

M-AUDIO

DCP-300

User Guide

Table of Contents

1	Introduction	4
2	Features	4
3	What's in the Kit	4
4	Controls and Connectors	5
	Right Panel	5
	Control Panel	6
	Connections Panel	8
	Rear Panel	8
5	Using DCP-300 for the First Time	9
	Connect the Pedal Board	9
	Connect the Power Cable	9
	Turn the Power On	10
	Set a Comfortable Volume Level	11
	Connect Headphones	12
	Using the Pedals	12
	Selecting Different Sounds	13
6	Additional Features	14
	Playing the Demo Songs (Demo Play Mode)	14
	Using the Metronome	15
	Metronome Volume	16
	Tempo	16
	Time Signature	17
	Using the Song Recorder (Song Record Mode)	18
	Song Playback	20
	Punch In	22
	Using the Reverb Effect	24
	Using the Chorus Effect	26
	Split Mode	28
	Layer Mode	31
	Using Split and Layer Modes Together	34
	Transpose Buttons	38
	Octave Function	39
	Master Tune	40
	Touch Select Mode	41
7	Resetting DCP-300: What to do if you need to Start Over	43
	Method 1: Piano Reset	43
	Method 2: Factory Reset	43
8	Using your Digital Console Piano with a Computer	44
	Computer System Requirements	44
	Connecting DCP-300 to your Computer	45
	Connecting the DCP-300 Auxiliary Input	46
	Installing Sibelius First Software	48
	Running Sibelius First Software	49

- 9 MIDI Functions52
 - Local On/Off52
 - MIDI Channel53
 - Data Control Assign54

- 10 Care and Maintenance55

- 11 Troubleshooting55

- 12 Appendices56
 - Appendix A – Defaults56
 - Default Settings56
 - Reverb and Chorus Defaults57
 - Piano Reset57
 - Appendix B - MIDI Implementation58
 - Appendix C - Data Control Assignments and MIDI CC List.59

- 13 Warranty61

1 Introduction

Congratulations on your purchase of the DCP-300 Advanced Digital Console Piano from M-Audio. DCP-300 combines state-of-the-art electronics with graded hammer keyboard action and elegant design, giving you a versatile musical instrument that is a joy to play, while adding beauty and sophistication to your home.

Professional musicians and recording studios around the world rely on M-Audio's market-leading USB MIDI controller keyboards. M-Audio digital pianos build on this legacy of quality and dependability, fusing industry-leading expertise in digital keyboard technology with world-class sounds. The DCP-300 piano is a beautifully designed, highly playable instrument equally suited for today's homes and houses of worship. And a single USB cable unlocks an entire world of additional functionality, allowing the DCP-300 piano to interface with a vast variety of music software including everything from fun-oriented education programs to professional recording and notation applications.¹

Whether you're new to musical instruments in general, or an experienced musician, please take some time to read through this user guide. It will help to familiarize you with the many features of DCP-300, so that you can get the most from your new piano.

¹ Computer and software setup instructions can be found in the section titled "Using Your Digital Console Piano with a Computer".

2 Features

- Graded Hammer action
- 64-Note Polyphony (maximum)
- Master Volume Control
- Treble and Bass Controls
- Built-in Reverb and Chorus effects
- 4 Touch Sensitivity Modes (Low, Normal, Hi, Fixed)
- Metronome with variable Tempo (20 to 280 bpm) and time signatures (2/2, 2/4, 3/4, 4/4, 5/4, 6/8, 7/8, 9/8, 12/8)
- Transpose (+/-12 semitones)
- Octave Shift (+/- 3 octaves)
- Layer Mode
- Split Mode
- Built-in 1-song/2-track Song Recorder with 28,000 note song memory
- 16 built-in high-quality sounds
- 16 Demo Songs
- USB 1.1 Full-Speed Class-Compliant (fully compatible with USB 2.0)
- Pedal Board with 3 pedals (Soft, Sostenuto and Sustain)
- Stereo Line output connectors
- Auxiliary Line In
- Two Headphone Outputs
- Sliding Key cover
- Hinged Music Stand
- Headphone Hook
- Built-in 40 watt 2-way (woofer/tweeter) Stereo Speaker system

3 What's in the Kit

Your DCP-300 console piano kit includes the following items:

- DCP-300 piano (assembly required)
- 1/8" TRS to 2x RCA adaptor cable
- This User Guide
- Sibelius First CD-ROM - Contents:
 - Sibelius First Installer PC and Mac
 - Documentation for Sibelius First
 - Extra content - piano scores suitable for loading into Sibelius First
- USB Cable
- IEC Power Cable
- Piano Bench (assembly required)

4 Controls and Connectors

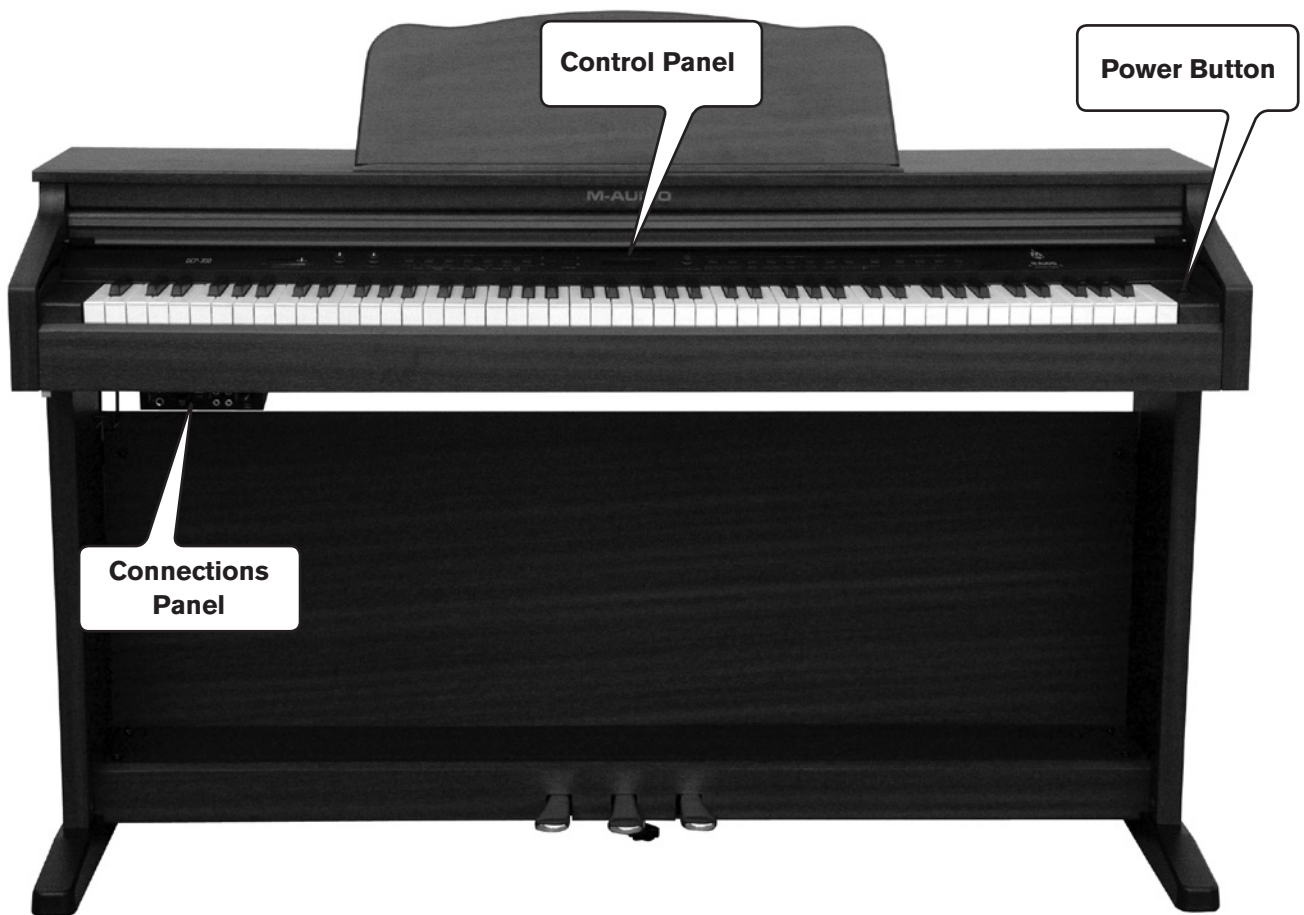

Right Panel

- 1 Power On/Off Switch – Pressing this button turns DCP-300 on or off.

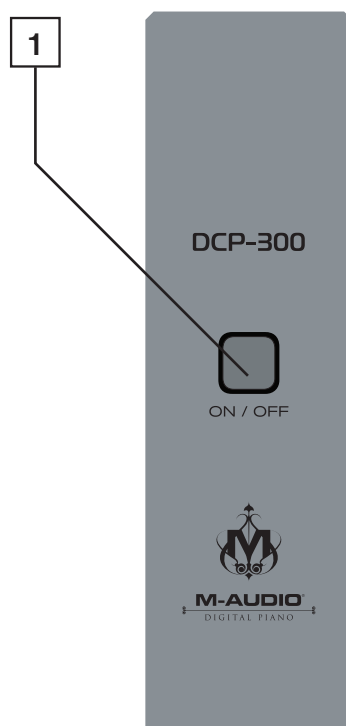

Control Panel

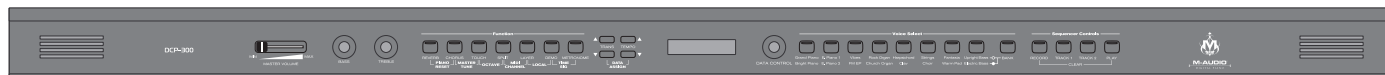

- 2 Master Volume** – Controls the overall volume of the piano, including the built-in speakers and the headphone outputs. Slide to the right to increase the volume, and to the left to decrease the volume. Please note that the Master Volume does not affect the volume of the Line Outputs [17](#).
- 3 Bass Control** – Controls the amount of bass (low frequency) content of the sound output. Turn clockwise to increase the bass, turn counter-clockwise to decrease.
- 4 Treble Control** – Controls the amount of treble (high frequency) content of the sound output. Turn clockwise to increase the treble, turn counter-clockwise to decrease.
- 5 Function Buttons** – Used to access various functions of DCP-300, including turning Chorus and Reverb on or off, setting Touch sensitivity, activating Split and Layer Modes, etc.
- 6 Transpose Buttons** – Used to transpose the pitch of the DCP-300 keyboard, and also may be used in combination with the Function buttons to enter data during certain editing functions.
- 7 Tempo Buttons** – Used to adjust the Metronome tempo, and also may be used in combination with the Function buttons to enter data during certain editing functions.
- 8 LCD (Liquid Crystal Display)** – The LCD shows information about the current parameters in Performance Mode, and provides information during editing functions.
- 9 Data Control Knob** – The Data Control knob is a multi-purpose control for entering and changing the settings of various functions. In its default setting it is assigned to change Voice Volume.
- 10 Voice Select Buttons** – Used in conjunction with the Bank button to select the sounds built into DCP-300.
- 11 Bank Button** – Toggles between the two banks of eight voices (sounds). Used with the Voice Select buttons to select the voices of DCP-300.
- 12 Sequencer Control Buttons** – Used to record and play back songs recorded in the internal sequencer (Song Recorder) of DCP-300.

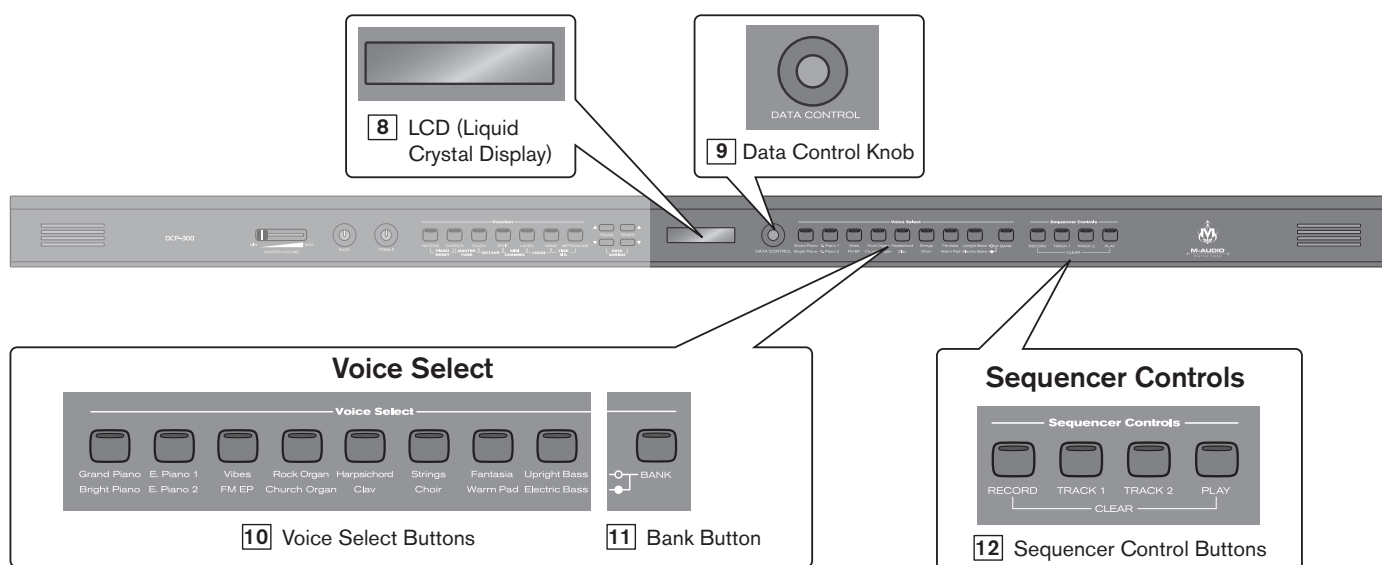
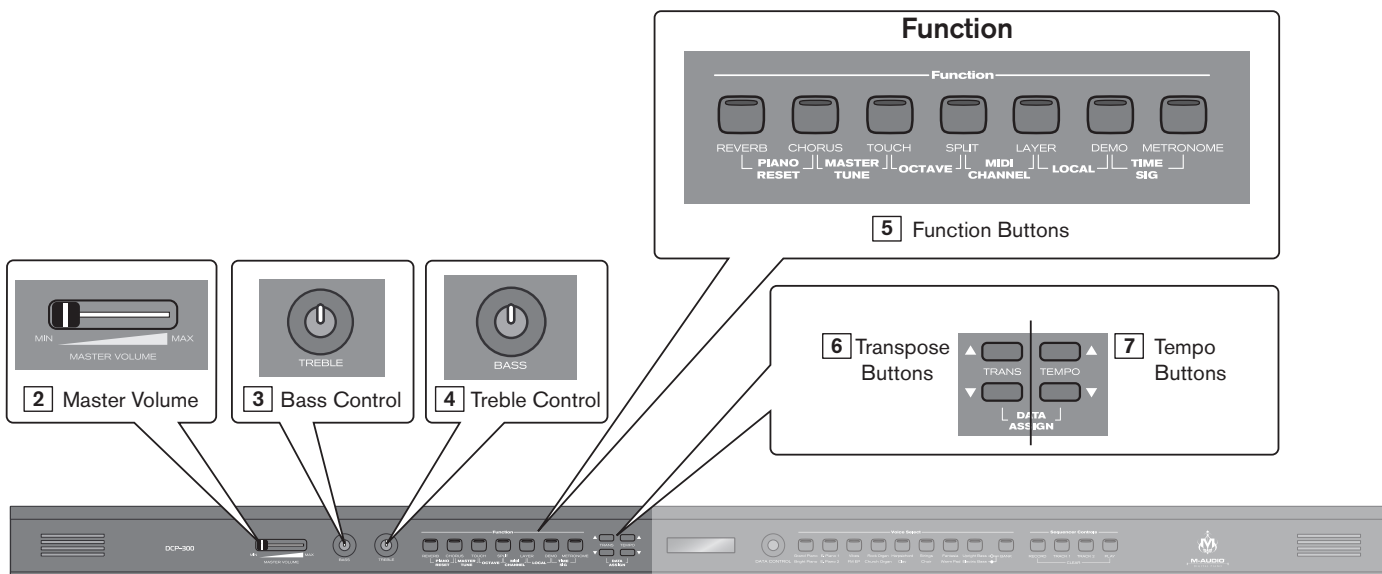

Connections Panel

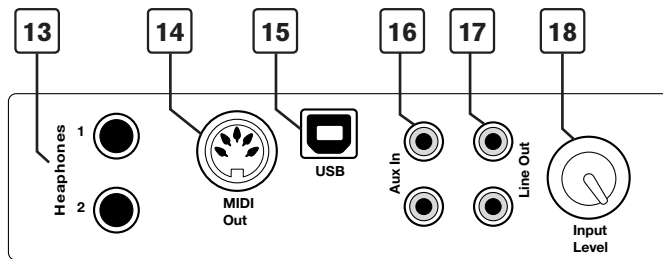

13. **Headphone Outputs** – Plugging a set of headphones into Headphone Output number 1 will disable the output from the internal speakers, allowing you to play without disturbing others. Plugging headphones only into the second (bottom) headphone output will not affect the speakers.
14. **MIDI Output** – This standard 5-pin MIDI connector sends MIDI output signal, for connecting to a computer or external MIDI device.
15. **USB Connector** – This is a standard USB 1.1 connector, for connecting to a computer’s USB port.
16. **Aux Line In** – These RCA connectors allow you to mix an external sound source (such as a CD player or computer output) with the piano’s internal sounds, for playback through the piano’s built-in speakers or headphone outputs.
17. **Line Out** – These RCA connectors can be used to connect the output of the piano to a stereo sound system, keyboard amplifier, mixing console or audio recorder. The level of the Line Output is not affected by the Master Volume slider.
18. **Aux Input Level** – This adjusts the input level of the signal connected to the Aux Line Inputs.

Rear Panel

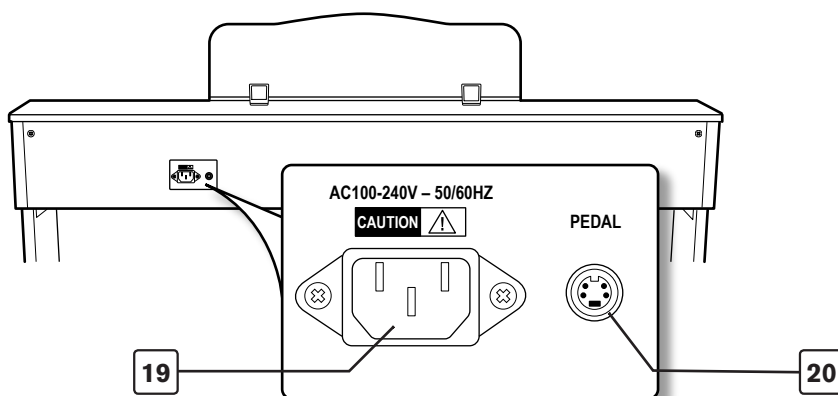

19. **Power Socket** – Connect the included 3-pin AC cable here, and plug the other end into an active AC outlet.
20. **Pedal Connector** – Connect the pedal board here.

5 Using DCP-300 for the First Time

Everything you need to know to start making music with DCP-300 is right here in this short section.

Connect the Pedal Board

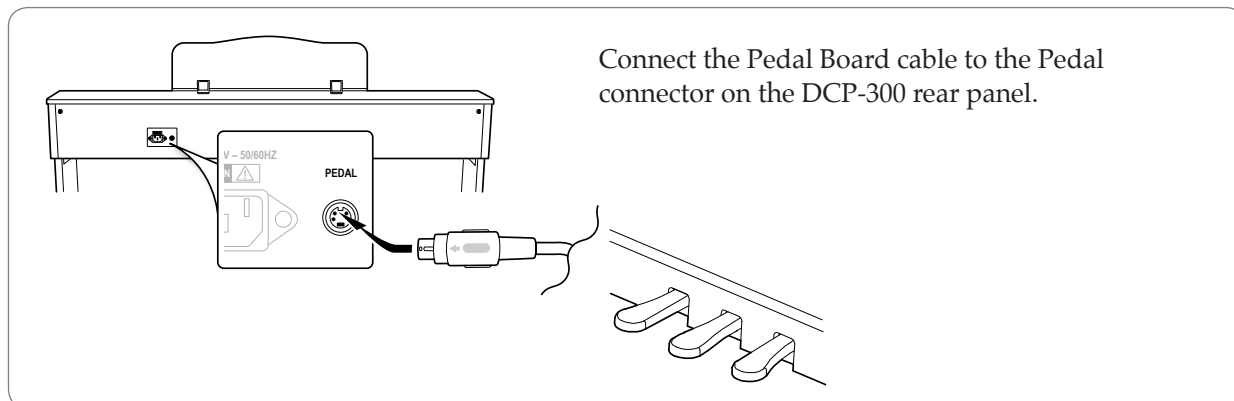

Connect the Power Cable

1



Make sure that the Power On/Off Switch is in the "Off" (up) position.

2

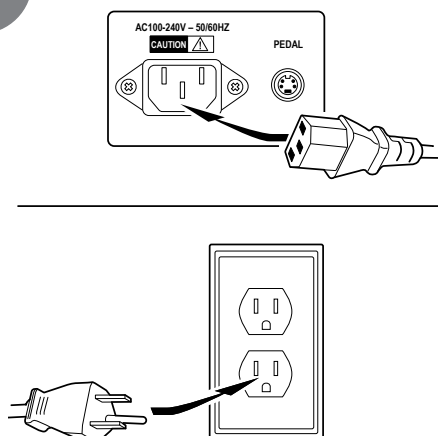

Connect the included AC cable to the Power Socket on the DCP-300 rear panel, and plug the other end into an active AC outlet.

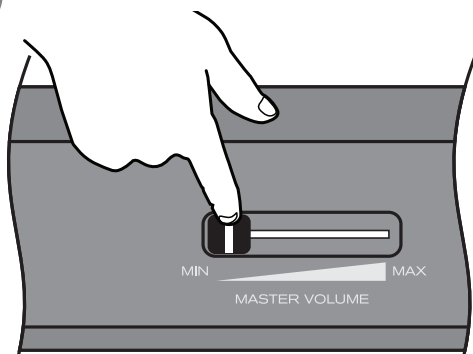
Turn the Power On**1**

Turn the Master Volume all the way down.

2

Press the Power On/Off switch to turn DCP-300 on.

The LCD will show Grand Piano. Grand Piano is the sound (or voice) that is automatically selected each time you turn on DCP-300.

Set a Comfortable Volume Level

1

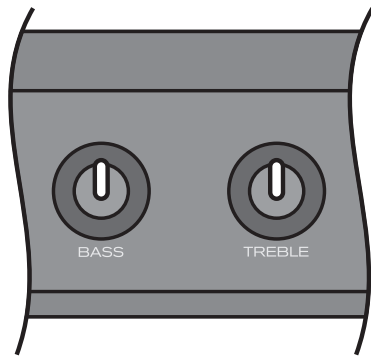

Set the Bass and Treble knobs to the 12 o'clock (neutral) position.

2

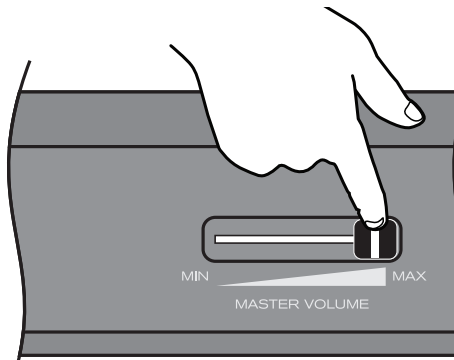

While playing the keyboard with your right hand, use your left hand to adjust the Master Volume control to a comfortable level. Move the slider left to decrease the volume level, and right to increase the volume level.

Once you have set a comfortable volume level, you may make adjustments to the bass and treble, although many users will be satisfied with the 12 o'clock (neutral) position.

Connect Headphones

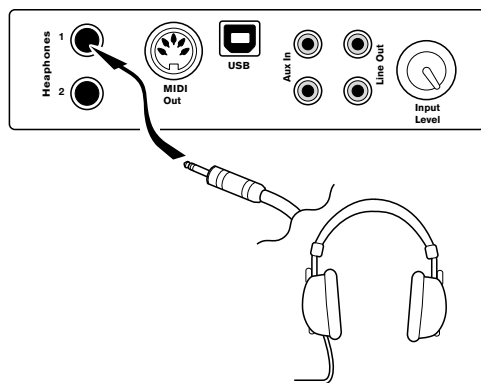

If you wish to use headphones while playing by yourself, plug your headphones into the top headphone output (Headphone Output 1). This will automatically turn off the speakers, so that you only hear sound through the headphones. Volume is still controlled by the Master Volume knob. Be sure the Master Volume is turned down before you put on your headphones, and then gradually turn it up to a comfortable level.

Note that plugging headphones only into the bottom headphone output (Headphone Output 2) does not automatically turn off the speakers. Headphone Output 2 is designed for use at times when you wish to practice quietly together with another person (such as a student), with both people wearing headphones. In this case, the speakers will still remain off, since headphones are also plugged into Headphone Output 1.

! *Warning: Using headphones at high volumes can permanently damage your hearing.*

Using the Pedals

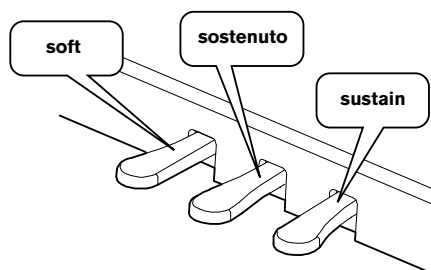

The pedal board has three pedals:

- **Soft Pedal** (Left Pedal): When this pedal is pressed, notes will sound slightly softer than they normally would if played with the same force without pressing the pedal.
- **Sostenuto Pedal** (Middle Pedal): The Sostenuto pedal acts as a selective damper pedal by sustaining specifically chosen notes. To use it, play and hold down a note or chord. Then press the sostenuto pedal. After releasing the keys, only those notes will continue to sustain until the sostenuto pedal is released.
- **Sustain Pedal** (Right Pedal): When this pedal is pressed, notes will continue to sustain even after the keys are released.

Selecting Different Sounds

The Voice Select buttons are used together with the Bank button to change the currently selected voice.

Under the Voice Select buttons are two rows of voice names (a top row and a bottom row). When the Bank button is off (not lit), the voice select buttons may be used to activate any of the voices listed on the top row (Bank A). When the Bank button is lit, voices from the bottom row (Bank B) may be selected.

In either case, the name of the currently selected voice will be shown on the LCD.

▶ Example of how to use the Voice Select buttons and the Bank button:

1

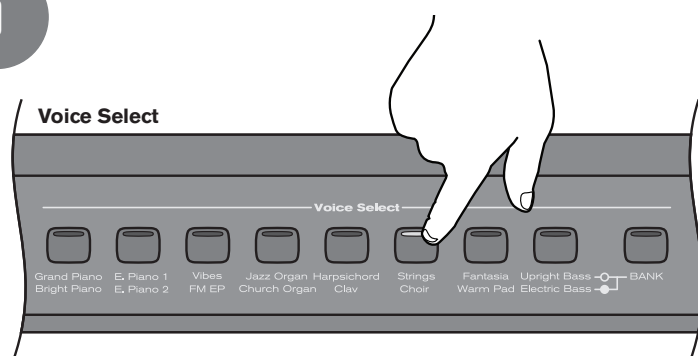

Press the sixth Voice Select button to select the Strings sound.

The button's blue LED will light up, and "Strings" will appear on the LCD. Play the keyboard to hear the Strings voice. Notice that the Bank button is not lit.

2

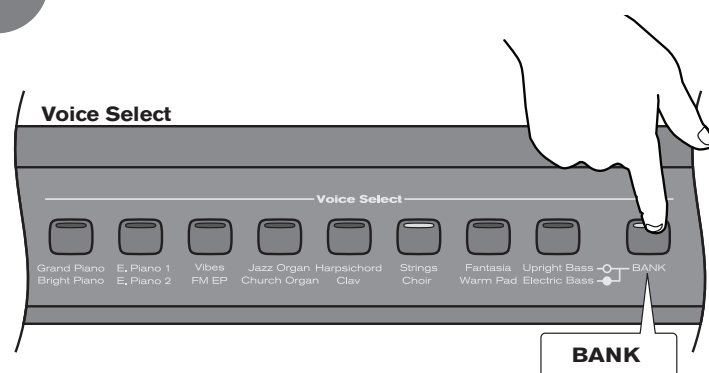

Press the Bank button.

The Bank button's blue LED will light up, and "Choir" will appear on the LCD. Play the keyboard to hear the Choir voice.

Of course, although the Strings and Choir voices were chosen for the example, the procedure is the same for all 16 available sounds.



Congratulations, you have learned all you need to know to be able to start enjoying your new digital piano. You can put this manual away and start playing music. If you want to learn about all the additional functionality DCP-300 has to offer (including how to play the built-in demo songs, use the metronome, and record your own songs using the built-in Song Recorder), please continue on to the "Additional Features" section.

6 Additional Features

Playing the Demo Songs (Demo Play Mode)

DCP-300 comes pre-programmed with a selection of sixteen demo songs. Each of the demo songs is designed to demonstrate one of the instrument voices built into DCP-300.

► To start demo song playback:

1

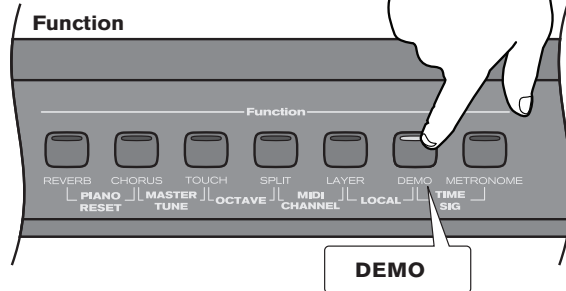

Press the Demo button to enter Demo Mode.

The display will show “DEMO,” and the Voice Select buttons will flash.

2

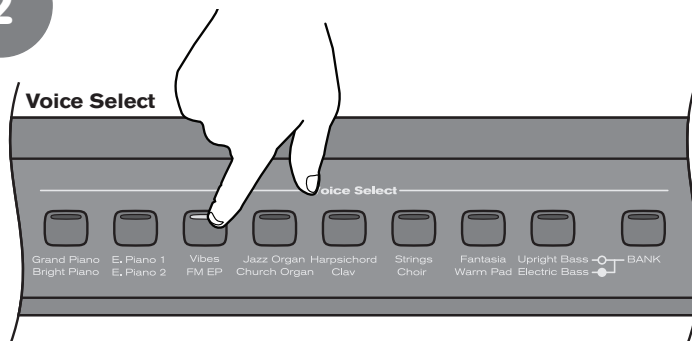

Press one of the Voice Select buttons to select a demo song.

The selected demo will play, and the corresponding Voice Select button will flash. If the Bank button is not lit, you will hear the Bank A voices (the top row of voices including Grand Piano, E. Piano 1, Vibes, etc.).

3

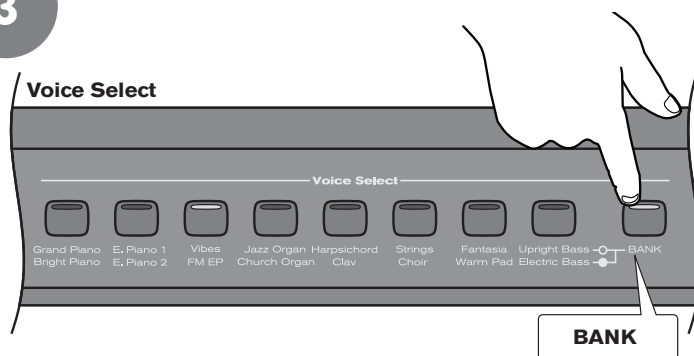

If you want to hear demo songs featuring the Bank B voices (the bottom row of voices including Bright Piano, E. Piano 2, FM EP, etc.), press the Bank button. It will light up.

While in Demo Mode, as long as the Bank button is lit, pressing a Voice Select button will cause the demo song featuring that button’s Bank B voice to play.

✓ Notes on playing demo songs:

- When the selected demo song has finished playing, the next demo song will play (following the order of the Voice Select buttons from left to right), and its corresponding Voice Select button will flash.
- When the last demo song of Bank A has finished playing, the first demo song of Bank B will begin. When the final demo song of Bank B ends, the first demo song of Bank A will begin again.

► **To stop demo song playback:**

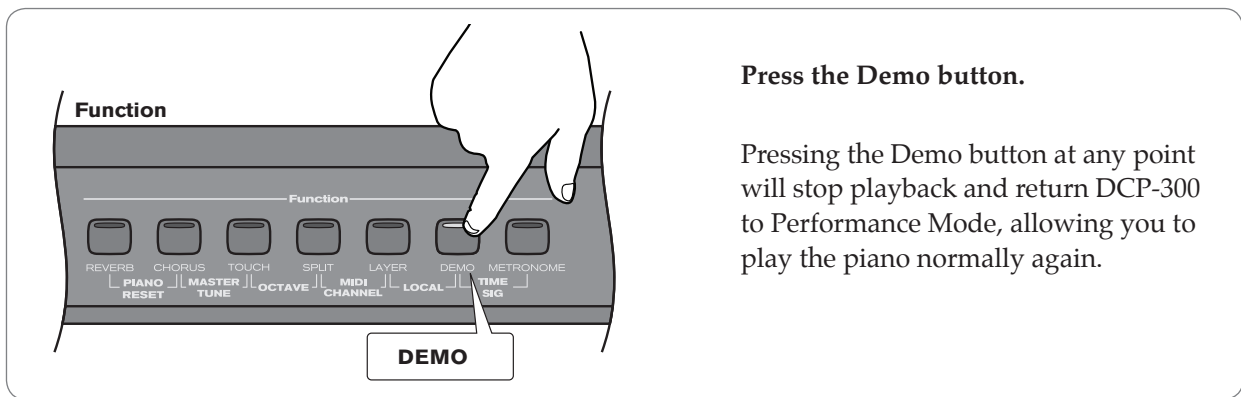

Using the Metronome

DCP-300 features a built-in metronome which can be used for practicing to a set tempo, and is also helpful when recording tracks into the Song Recorder. The metronome will sound a high tone on the first beat of a bar, and a lower tone on the remaining beats of the bar. The Metronome button's LED will also flash in time.

► **To start the Metronome:**

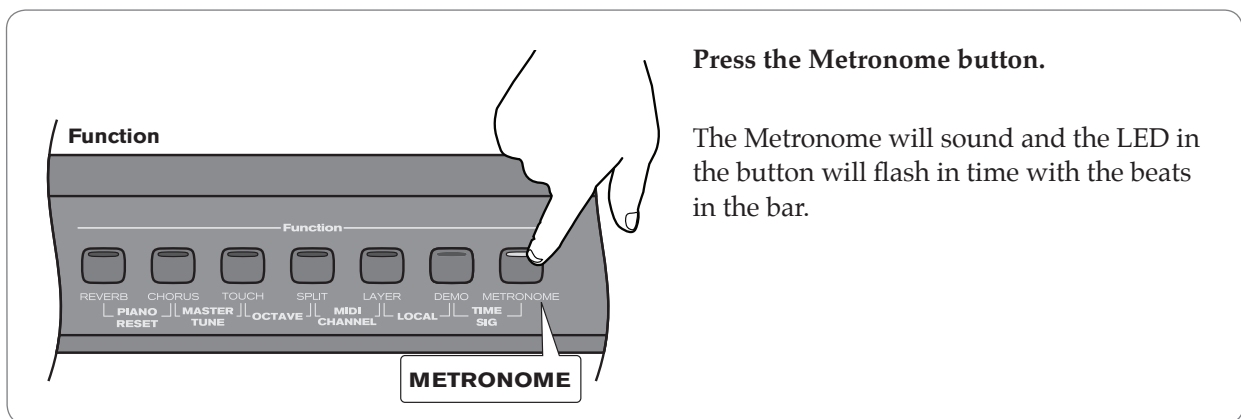

► **To stop the Metronome:**

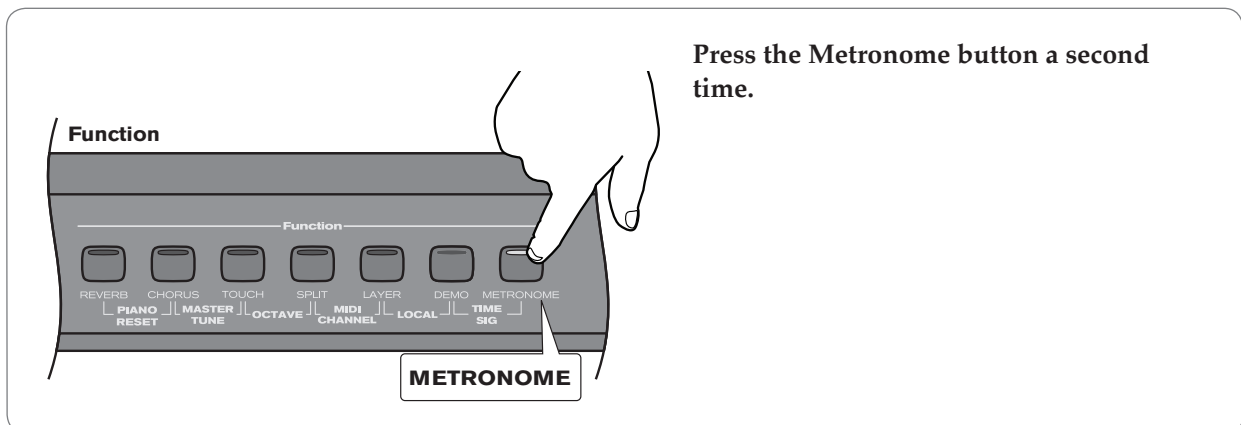

Metronome Volume

The metronome volume can be raised or lowered.

► **To change the metronome's volume:**

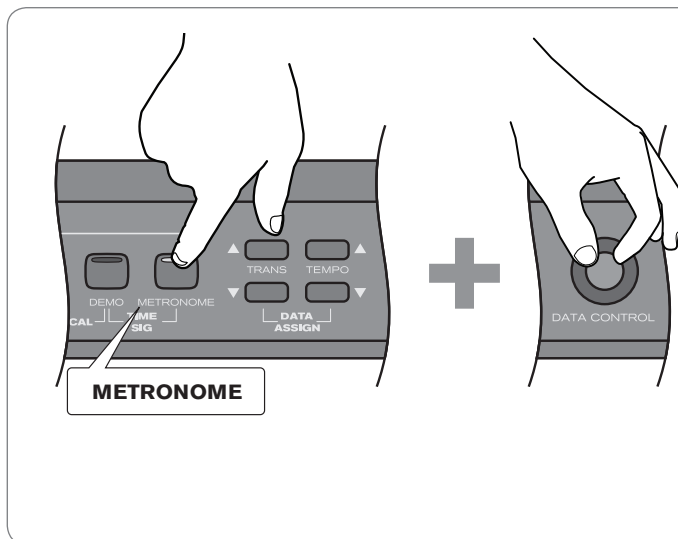

While holding down the Metronome button, turn the Data Control knob clockwise to increase volume, or counter-clockwise to decrease volume.

The LCD will show the current Metronome Volume level. This can be adjusted between zero (minimum) and 127 (maximum). When you have set a comfortable level, let go of the Metronome button.

Tempo

The Metronome can be programmed for any tempo between 20 beats per minute (bpm) and 280 bpm.

► **To change the Metronome's tempo:**

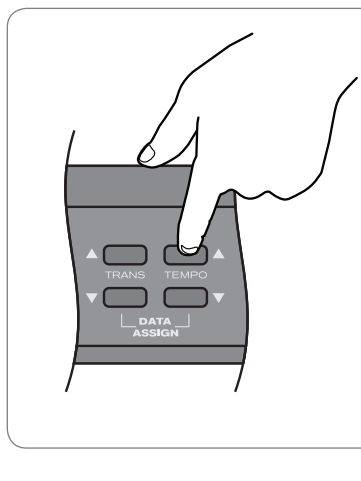

Use the Tempo Up/Down buttons (Up button increases tempo, Down button decreases tempo).

✓ **NOTE:** Pressing both Tempo Up/Down buttons simultaneously will reset the Tempo to its default value of 120 bpm.

Time Signature

The metronome can support the following time signatures:

2/2, 2/4, 3/4, 4/4, 5/4, 6/8, 7/8, 9/8, 12/8

► To change the metronome's time signature:

1

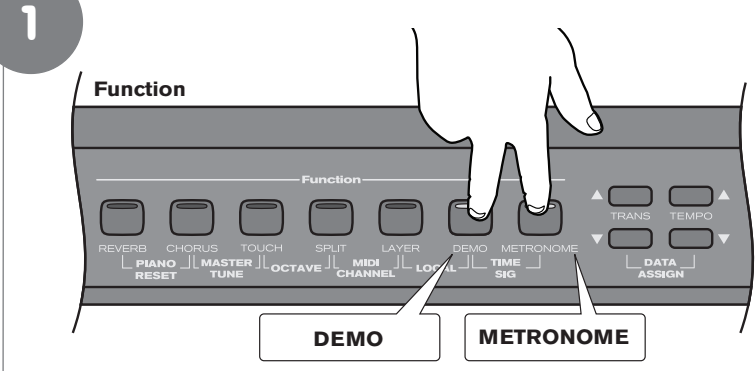

Press the **Demo** and **Metronome** buttons at the same time to enter **Time Signature Edit Mode**.

The top line of the LCD will show: **Time Sig: 4/4**

2

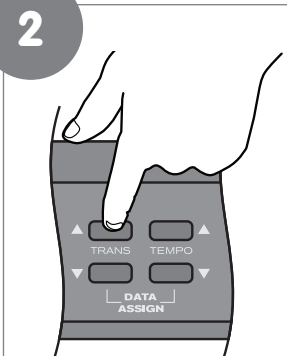

Use the **Transpose Up** or **Down** button to change the **Time Signature**.²

You step through the time signatures in the following order:
2/2, 2/4, 3/4, 4/4, 5/4, 6/8, 7/8, 9/8, 12/8

² Note that you can use the **Data Control knob** instead of the **Transpose Up/Down** buttons to change the **Time Signature**.

✓ **NOTE:** After pressing the **Demo** and **Metronome** buttons in **Step 1**, you will have three seconds to begin using the **Transpose Up** or **Down** buttons (or the **Data Control knob**) to change the **Time Signature**. After three seconds, the piano goes back to **Performance Mode** (the basic “play the piano” setting), and the **LCD** goes back to its main screen. This three-second “**Time Out**” function is common to most of the editing functions of **DCP-300**.

► To reset the Time Signature to its default value of 4/4:

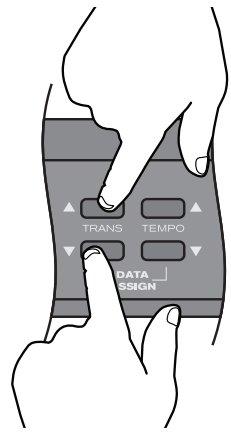

While in **Time Signature Edit Mode**, press the **Transpose Up** and **Down** buttons at the same time.

✓ **NOTE:** **Time signature** and **Tempo** cannot be changed while recording a song. The **time signature** or **tempo** must be selected before starting to record.

Using the Song Recorder (Song Record Mode)

The Song Recorder (or sequencer) built into DCP-300 can record two individual tracks, allowing you to record one part and then play and record a second complementary part while the first part plays back.

► To record a track:

1

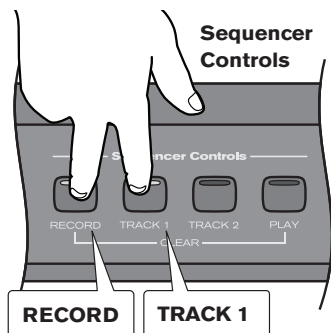

Simultaneously press the Record button and the Track 1 button to record on Track 1.

or

Simultaneously press the Record button and the Track 2 button to record on Track 2.

The Metronome will begin counting, but recording will not start yet. This is called Record Wait Mode.

2



Start playing the keyboard. Recording starts as soon as you play the first note.



NOTE: When Record Wait Mode is active, you can also start recording by pressing the Play button. In that case, the Song Recorder will record silence until you start playing the keyboard.

3

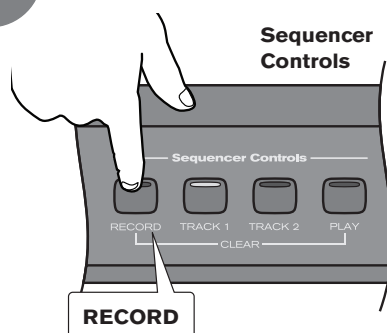

When you are finished playing, press the Record button again to stop recording.



NOTE: The Metronome may be turned off or on at any time while in Record Wait Mode, or during recording. To turn off the Metronome, press the Metronome button.

► To erase (clear) a track:

1

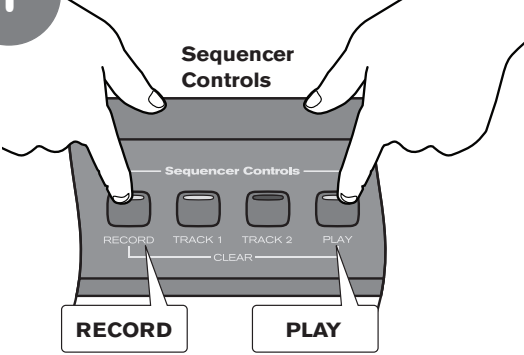

The diagram shows a hand holding a device with a control panel labeled "Sequencer Controls". The panel has four buttons: "RECORD", "TRACK 1", "TRACK 2", and "PLAY". A "CLEAR" label is positioned below the "TRACK 1" and "TRACK 2" buttons. Two callout boxes, "RECORD" and "PLAY", point to their respective buttons. A hand is shown pressing both the "RECORD" and "PLAY" buttons simultaneously.

Sequencer Controls

Press the Record and Play buttons simultaneously.

Note that the button for any track onto which material has been recorded will light.

2

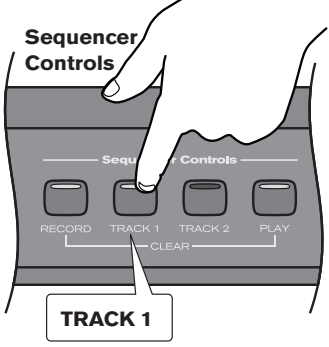

The diagram shows a hand holding the same device. A hand is shown pressing the "TRACK 1" button. A callout box labeled "TRACK 1" points to the button.

Sequencer Controls

Press the Track button for the track you wish to erase.

✓ **NOTE:** Once the Clear function has been used to erase a track, this action cannot be undone. The track will be permanently erased.

Song Playback

During song playback, the Track buttons are used to determine which tracks will be audible during playback.

► To start song playback:

1

Sequencer Controls

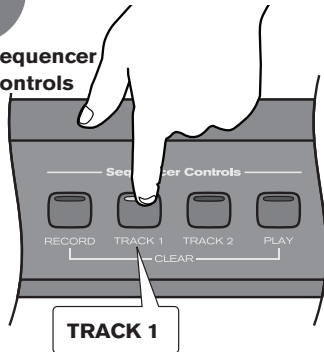

Press the Track button of the track you wish to hear, so that the button lights up. (If the desired Track button is already lit, you can skip this step and proceed to Step 2).

Note that if there is nothing recorded on the track, the Track button will not light up, even if you press the button.

2

Sequencer Controls

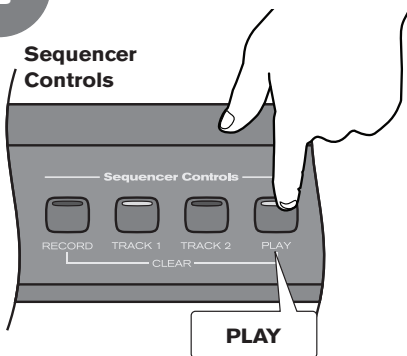

Press the Play button to begin playback.

Note that pressing the Play button again during playback will stop playback.

Also note that during playback, either (or both) Track buttons can be pressed at any time to make the corresponding track audible or inaudible. Playback will continue until the end of the recording, even if neither Track button is lit.

► To play a previously recorded track while recording a second track:

1

Sequencer Controls

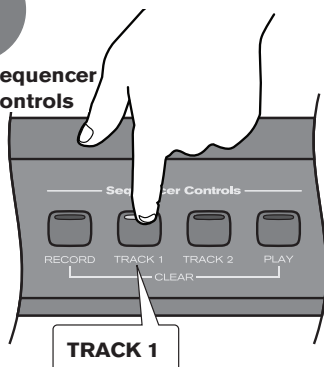

Press the Track button of the previously recorded track you wish to hear, so that its blue LED is lit.

(If the Track button for the track you wish to hear is already lit, you can skip this step and proceed to Step 2).

2

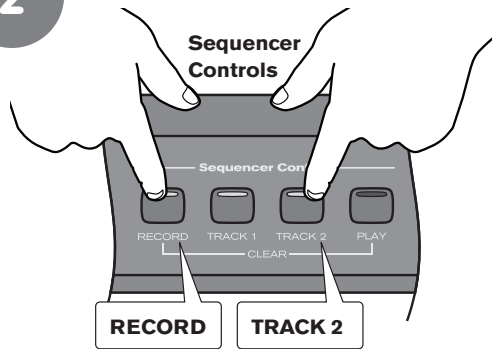

Simultaneously press the Record button and the Track button of the track you wish to record on. This will start the Metronome.

3



Start playing the keyboard. Recording starts as soon as you play the first note (as does playback of the previously recorded track).



NOTE: When Record Wait Mode is active, you can also start recording by pressing the Play button. In that case, the Song Recorder will record silence until you start playing the keyboard.

4

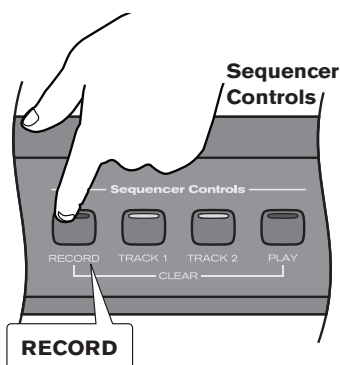

When you are finished playing, press the Record button again to stop recording.



Note: If you have already recorded a performance on Track 1, and would like to record an independent performance on Track 2 (without hearing Track 1 as you record), you can make sure the Track 1 button is not lit (pressing it if necessary), before beginning to record on Track 2. When used this way, the song recorder allows you to record and play back two "single track songs" instead of one "two track song."

Punch In

In recording jargon, “punching in” refers to recording over a portion of a previously recorded track, usually to fix a mistake. The previously recorded track plays up to the point of the mistake (the “punch in point”), at which time recording is activated on the track.

► To punch in on a previously recorded track:

1

Sequencer Controls

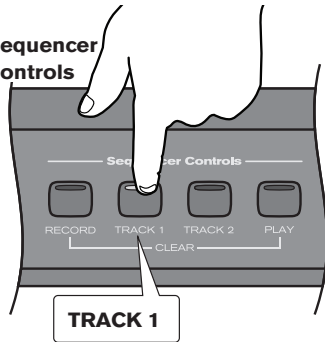

Press the Track button(s) for the track(s) you would like to hear so that the button(s) are illuminated.

(If the Track button for the track you wish to hear is already lit, you can skip the above step and proceed to Step 2.)

2

Sequencer Controls

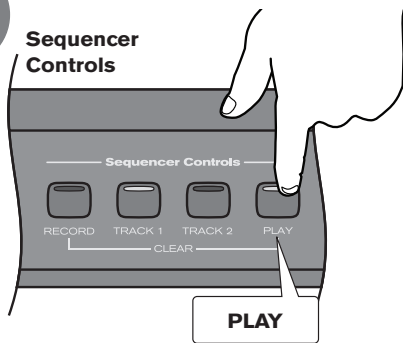

Press the Play button.

3

Sequencer Controls

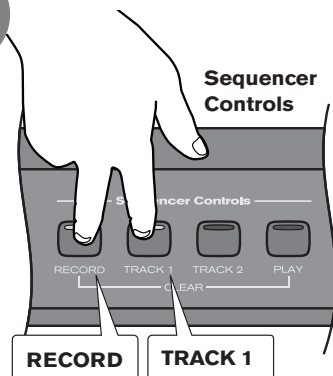

When the song reaches the point at which you would like to punch in, press the Record button and the Track button (for the track you want to record over) at the same time. The Record LED will light and the Play LED will go out.

4



Play the keyboard to record your new performance.

5

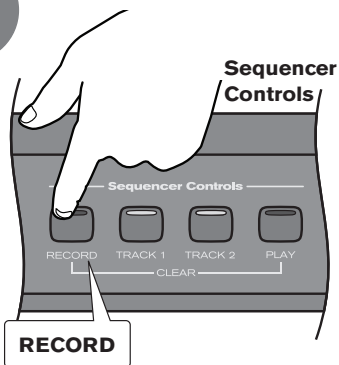

To stop recording, press the Record button again.



Note: Once you have punched in, the old data on the selected track will be cleared from the punch in point to the end of the track, even if Record Mode is stopped before the end of the original recording, and even if no new notes have been played.

Using the Reverb Effect

The built-in digital Reverb can be used for adding a natural-sounding room ambience to any of the 16 voices built into DCP-300.

► To apply Reverb to a voice:

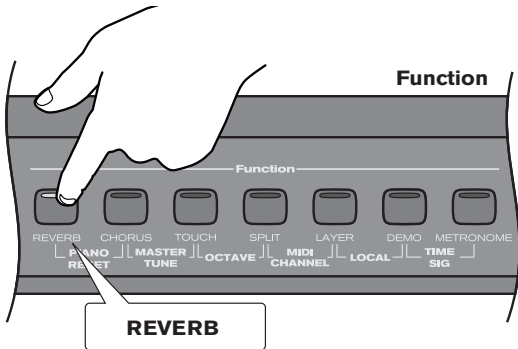

Press the Reverb button.

The button will illuminate, and you will hear the Reverb effect when you play the currently selected voice.

To turn Reverb off, press the Reverb button again. The button will go dark to indicate that Reverb is off.

► To adjust the Reverb Depth (Reverb amount):

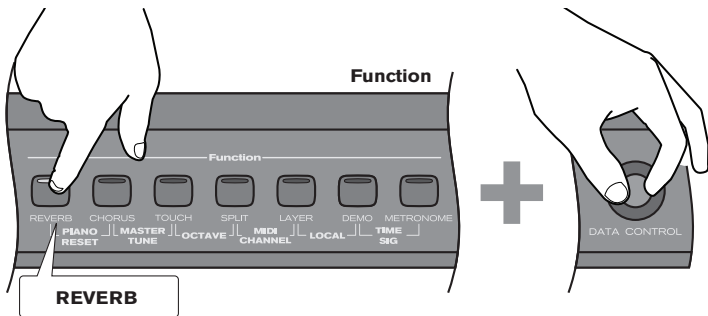

While holding the Reverb button, turn the Data Control knob to adjust the Reverb Depth setting.

The LCD will show the current Reverb Depth setting. The minimum setting is 0, and the maximum setting is 127.

Once you have reached the desired amount of Reverb, let go of the Reverb button, and resume playing DCP-300.

✓ **Note:** If you prefer, you may use the Tempo Up/Down buttons instead of the Data Control knob to change the Reverb Depth (while holding down the Reverb button).

► **To change the Reverb Type:**

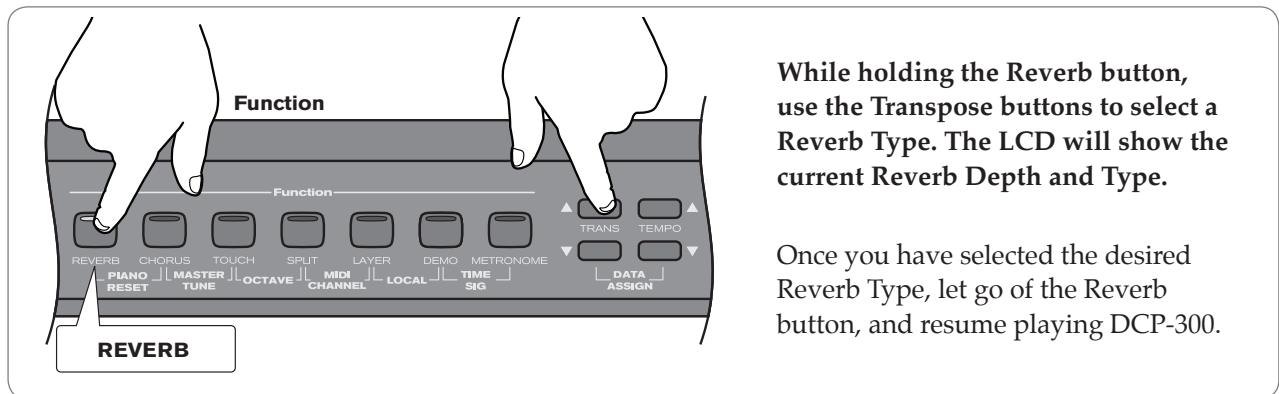

The following Reverb Types are available:

- Room 1
- Room 2
- Room 3
- Hall 1
- Hall 2
- Plate
- Delay
- Pan Delay

Each of the 16 voices of DCP-300 will remember its individual Reverb on/off status, Type and Depth setting, even after turning the Power switch off and on.

Using the Chorus Effect

The built-in digital Chorus can be used for adding a rich, swirling stereo effect to any of the 16 voices built into DCP-300.

► To apply Chorus to a voice:

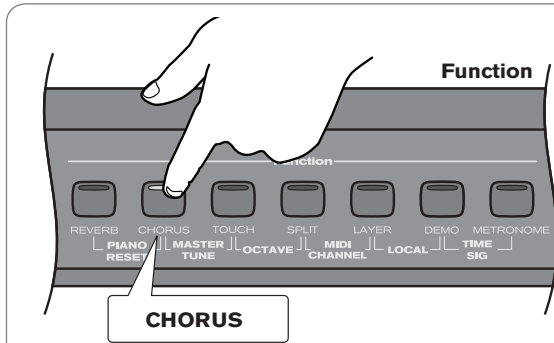

Press the Chorus button. The button will illuminate, and you will hear the Chorus effect when you play the currently selected voice.

To turn Chorus off, press the Chorus button again. The button will go dark to indicate that Chorus is off.

✓ **Note:** Depending on the default Depth setting for the selected Chorus preset, the effect may be quite subtle. To hear the Chorus more clearly, you may want to increase the Chorus Depth, as described in the next step.

► To adjust the Chorus Depth (Chorus amount):

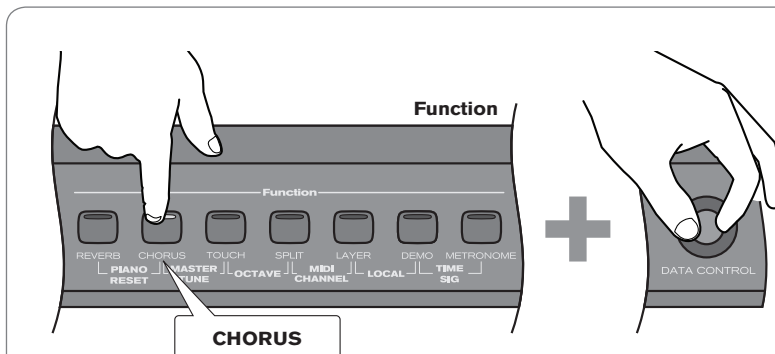

While holding the Chorus button, turn the Data Control knob to adjust the Chorus Depth setting. The LCD will show the current Chorus Depth and Type.

Once you have the desired amount of Chorus, let go of the Chorus button, and resume playing DCP-300.

✓ **Note:** If you prefer, you may use the Tempo Up/Down buttons instead of the Data Control knob to change the Chorus Depth (while holding down the Chorus button).

► **To change the Chorus Type:**

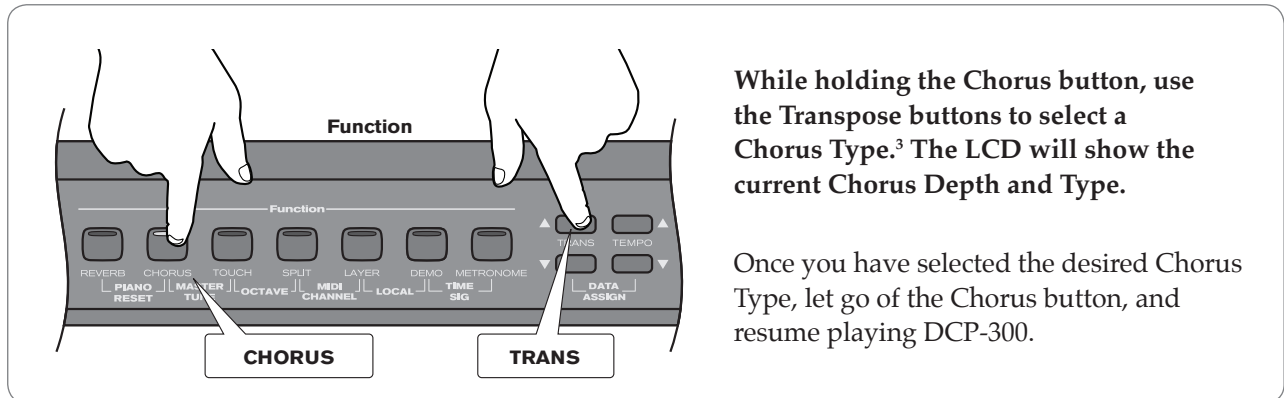

While holding the Chorus button, use the Transpose buttons to select a Chorus Type.³ The LCD will show the current Chorus Depth and Type.

Once you have selected the desired Chorus Type, let go of the Chorus button, and resume playing DCP-300.

³ In addition to five Chorus types, you can also choose from a Flanger and two Delay effects as listed in the table below.

The following Chorus/Effect Types are available:

- Chorus 1
- Chorus 2
- Chorus 3
- Chorus 4
- FB Chorus
- Flanger
- Short Delay
- FB Delay

Each of the 16 voices of DCP-300 will remember its individual Chorus on/off status, Type and Depth setting, even after turning the Power switch off and on.

✓ **TIME OUT!**

As you use DCP-300, you may notice there is no “Enter” button. That is because whenever you press the appropriate Function button(s) to edit a setting such as Time Signature, Octave, Master Tune, or MIDI Channel (or use the Data Assign function), the selected function will “time out” after three seconds, automatically accepting whatever selection or change you have made (if any). If you have made no changes, the LCD will go back to normal after 3 seconds.

Split Mode

In Split Mode, the keyboard is divided into two parts, with each part playing a different sound. This allows you to play two different instruments, for example, bass with your left hand and piano with your right hand.

In Split Mode, the Split Voice will play on all keys to the left of, and including the Split Point (explained on the next page). The Main Voice will play on all keys to the right of the Split Point.

► To turn on Split Mode:

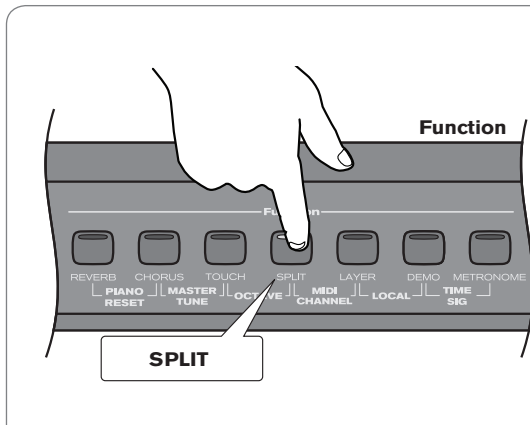

Press the Split button.

The LCD's first line will show the Main Voice and split point. The second line will show the Split Voice and the Split Voice volume setting:

Grand Piano Eb3
Up.Bass Vol:127

✓ **NOTE:** In most cases, the number in the lower right corner of the LCD represents the current value of the Data Control knob. While in Split Mode, the Data Control knob defaults to controlling the Split Voice Volume. However, if you have assigned the Data Control knob to control a different function, the value for your custom setting will be displayed instead of the Split Voice Volume. For information on how to assign the Data Control knob to control different functions, see the "Data Control Assign" section in **Chapter 9: MIDI Functions**.

► To change the Split (left hand) Voice:

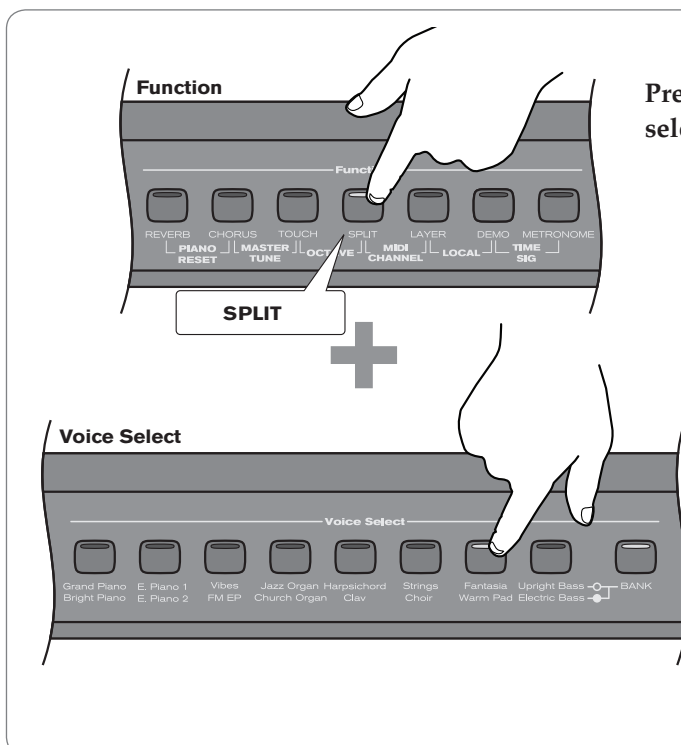

Press and hold the Split button while selecting a Voice Select button.

► **To change the Main (right hand) Voice:**

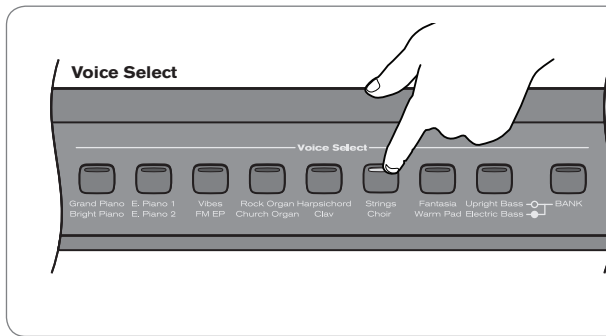

Press a Voice Select button (without pressing the Split button).

► **To change the Split point:**

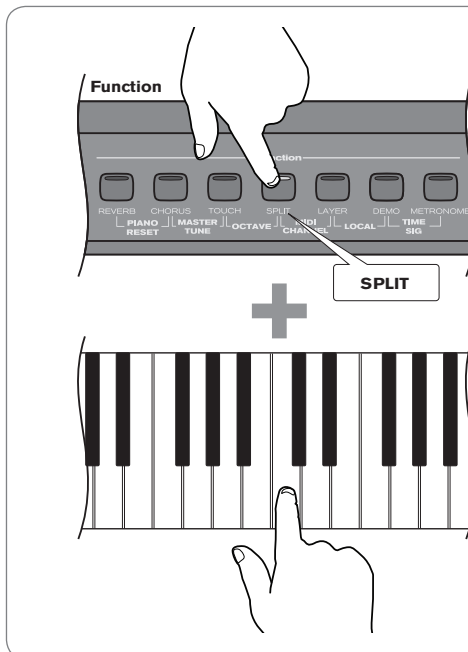

Press and hold the Split button while pressing the highest note to be included in the Split zone (i.e., the highest note to be played with the left hand voice).

► **To change the volume of the Split Voice:**

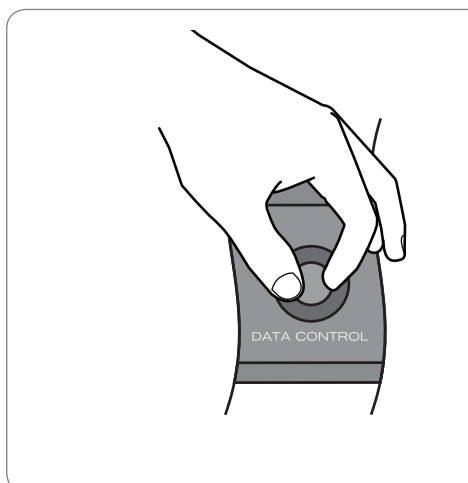

Turn the Data Control knob to select a volume setting between 0 and 127.

As long as you are in Split Mode, the Data Control knob controls the volume of the Split Voice (left hand voice).

► **To change the volume of the Main Voice (right hand voice):**

1

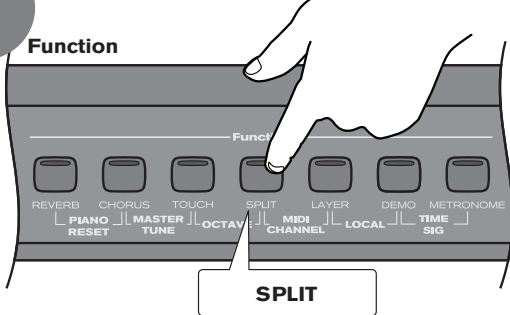

Function

REVERB CHORUS TOUCH SPLIT LAYER DEMO METRONOME
PIANO MASTER OCTAVE MIDI CHANNEL LOCAL TIME
RESET TUNE SIG

SPLIT

Press the Split button to turn off Split Mode.

2

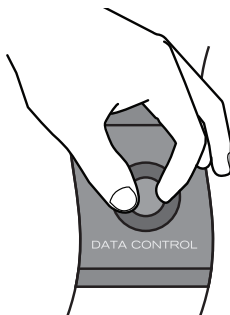

DATA CONTROL

Turn the Data Control knob to select a volume setting between 0 and 127.

3

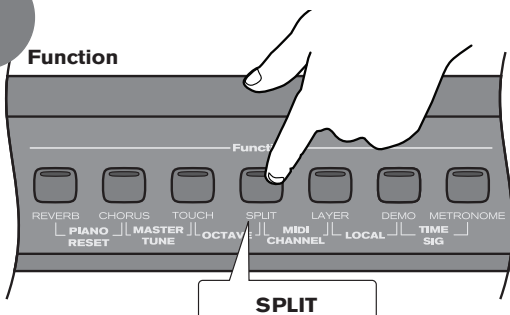

Function

REVERB CHORUS TOUCH SPLIT LAYER DEMO METRONOME
PIANO MASTER OCTAVE MIDI CHANNEL LOCAL TIME
RESET TUNE SIG

SPLIT

Press the Split button to turn Split Mode back on.

► **To turn off Split Mode:**

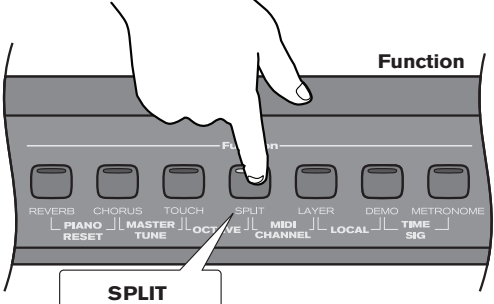

Function

REVERB CHORUS TOUCH SPLIT LAYER DEMO METRONOME
PIANO MASTER OCTAVE MIDI CHANNEL LOCAL TIME
RESET TUNE SIG

SPLIT

Press the Split button again.

✓ **Note to MIDI users:**

The Main Voice (right hand voice) will transmit on the selected Main MIDI Transmit Channel. The Split Voice (left hand voice) will transmit on the Main MIDI Transmit Channel +1. For information on setting the Main MIDI Transmit Channel, please see the “MIDI Channel” section in **Chapter 9: MIDI Functions**.

The default values for Split Mode are:

- Default Split Point: Eb3
- Default Split Voice: Upright Bass

Layer Mode

In Layer Mode, DCP-300 will play two voices simultaneously on each key.

► **To turn on Layer Mode:**

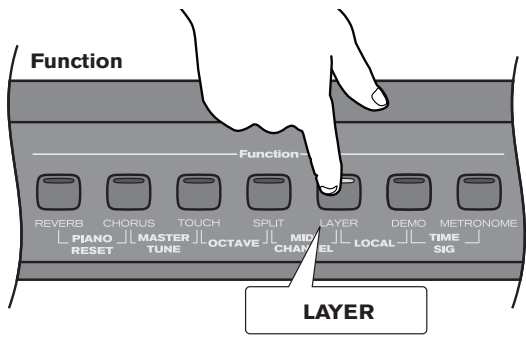

Press the Layer button.

The LCD's top line will show the Main Voice (first) and the Layer Voice (second). The bottom line will show the tempo and the Layer Voice volume.

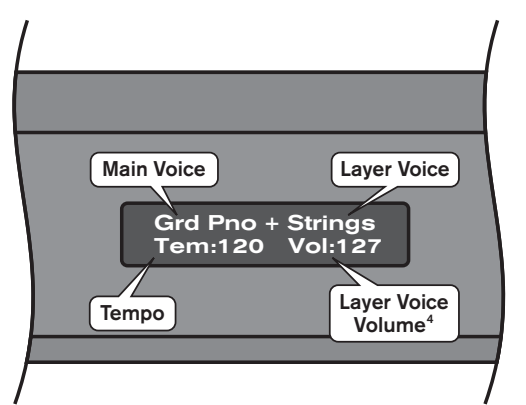

⁴ In most cases, the number in the lower right corner of the LCD represents the current value of the Data Control knob. While in Layer Mode, the Data Control knob defaults to controlling the Layer Voice Volume. However, if you have assigned the Data Control knob to control a different function, the value for your custom setting will be displayed instead of the Layer Voice Volume. For information on how to assign the Data Control knob to control different functions, see the "Data Control Assign" section in Chapter 9: MIDI Functions.

Please note that polyphony may be reduced while Layer Mode is in use.

► **To change the Main Voice:**

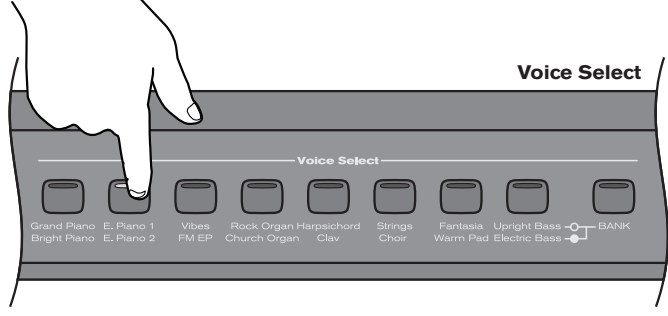

Press a Voice Select button.

► **To change the Layer Voice:**

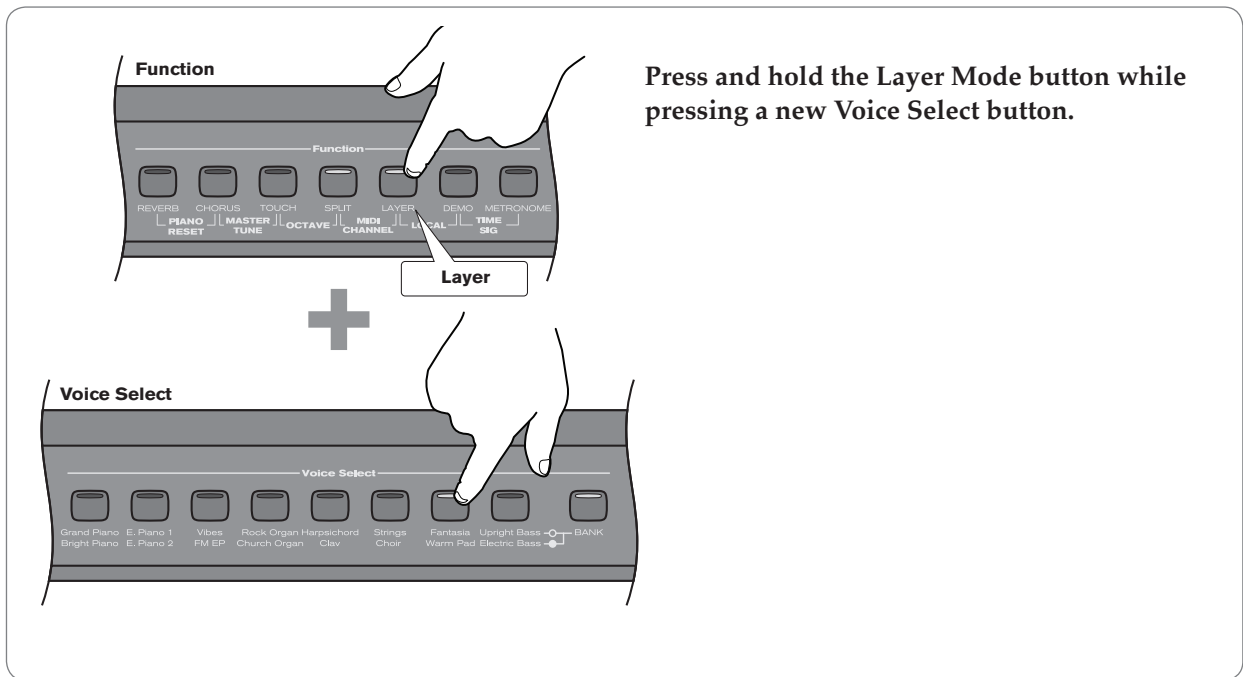

► **To adjust the volume of the Layer Voice:**

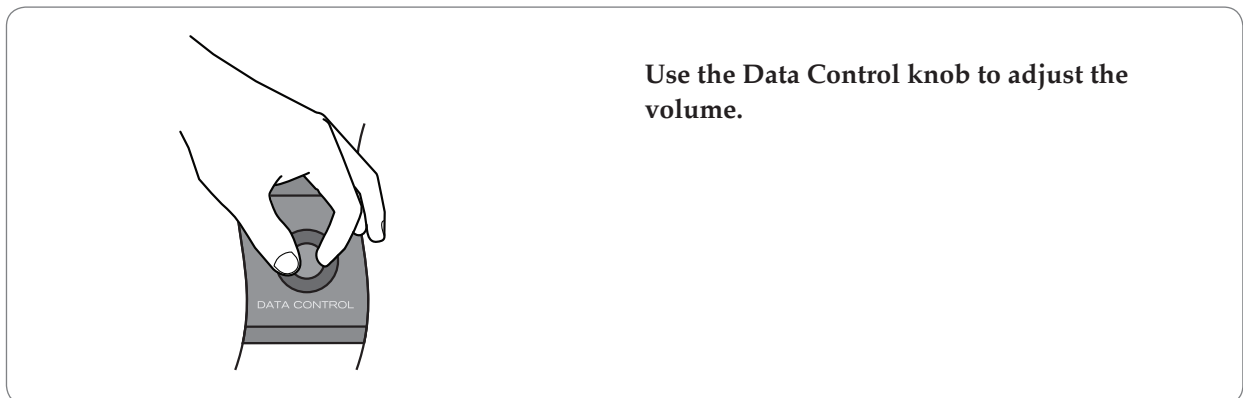

► **To adjust the volume of the Main Voice:**

1

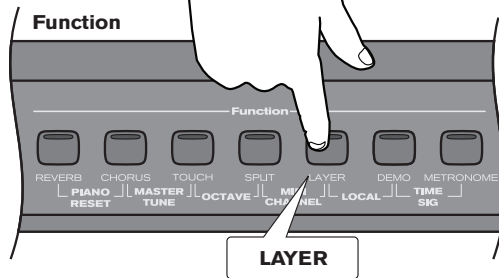

Press the Layer button to turn off Layer Mode.

2

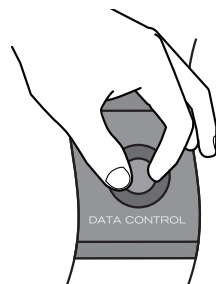

Use the Data Control knob to adjust the Main Voice volume.

3

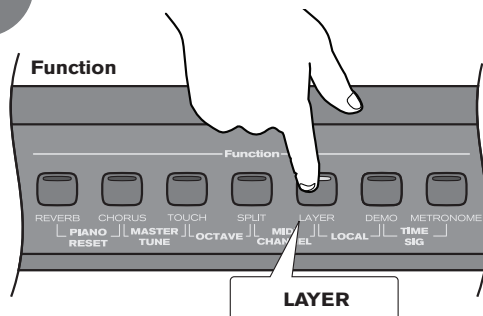

Press the Layer button again to turn Layer Mode back on.



Note to MIDI users: The Main Voice will be transmitted on the selected Main MIDI Transmit Channel. The Layer Voice will be played on the selected Main MIDI Transmit Channel +2. For information on setting the Main MIDI Transmit Channel, please see the “MIDI Channel” section in **Chapter 9: MIDI Functions**.

► **To turn off Layer Mode:**

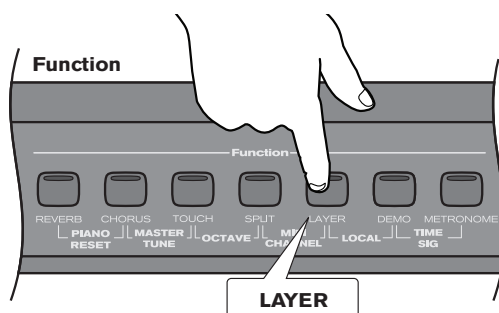

Press the Layer button. The Layer button’s LED will go dark.

Using Split and Layer Modes Together

When Split and Layer Modes are both enabled, Layer Mode will take priority, so the Data Control knob will be automatically assigned to control the volume level for the Layer Voice. If Layer Mode and Split Mode are both active, the Layer Voice will be added only to the Main Voice, not to the Split Voice. In other words, playing to the right of the Split Point will sound the Main and Layer Voices. Playing to the left of the Split Point will sound only the Split Voice.

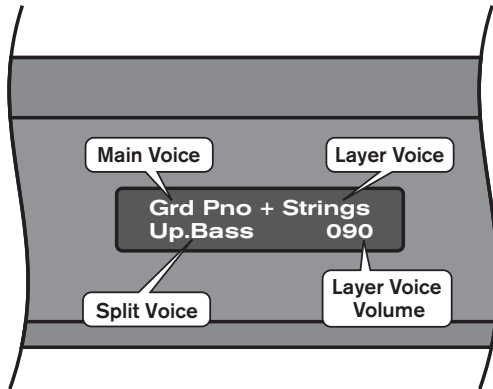

The LCD will show a combination of all the voice information, and the Data Control knob value (which is the Layer Voice volume by default).

<Main Voice>+<Layer Voice>

<Split Voice> <Layer Voice Volume>

For example, the image on the left shows a setup with Grand Piano as the Main Voice, Strings as the Layer Voice and Upright Bass as the Split Voice.

Note that the following instructions regarding using Layer Mode and Split Mode together are actually the same as if you were using either of the two modes separately, with the exception of the method for changing the Split Voice volume (which is different when using the two modes together).

► To change the Layer Voice:

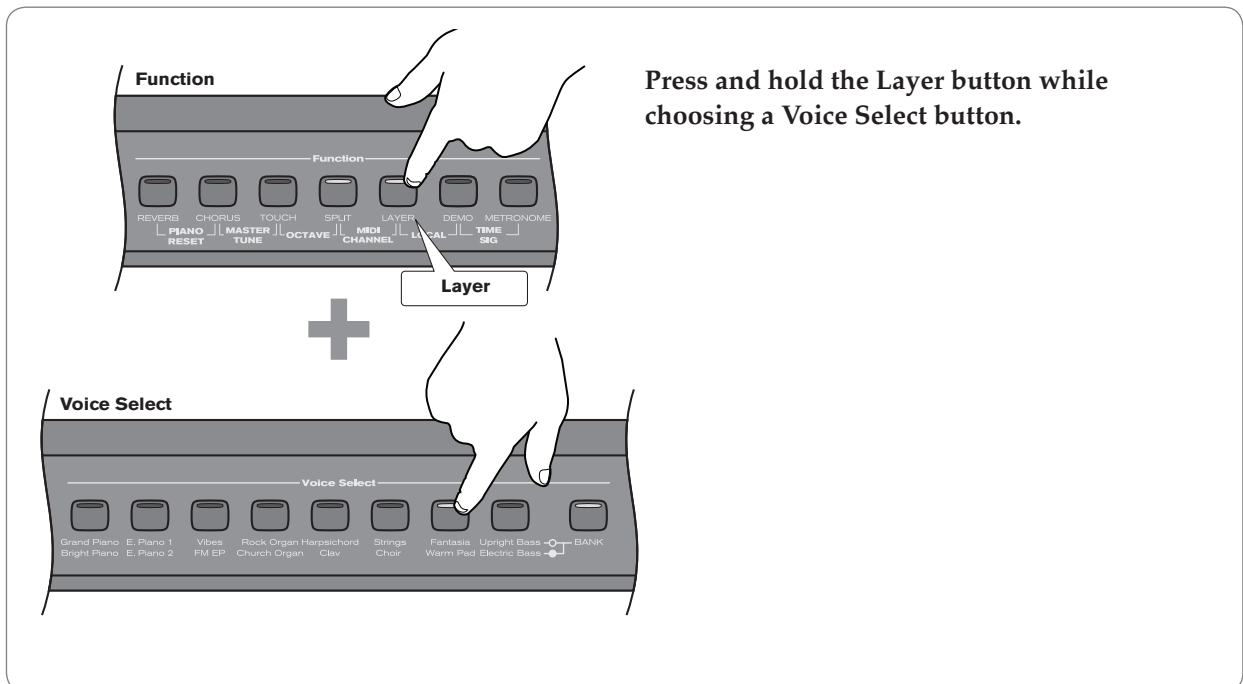

Press and hold the Layer button while choosing a Voice Select button.

► **To change the Split Voice:**

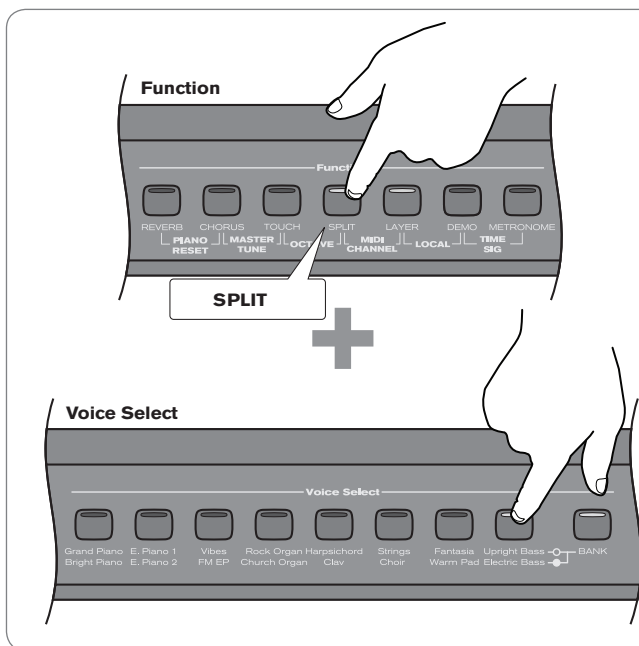

Function

REVERB CHORUS TOUCH SPLIT LAYER DEMO METRONOME
PIANO MASTER OCTAVE MIDI LOCAL TIME
RESET TUNE VE CHANNEL LOCAL SIG

SPLIT

Voice Select

Grand Piano E. Piano 1 Vibes Rock Organ Harpsichord Strings Fantasia Upright Bass BANK
Bright Piano E. Piano 2 FM EP Church Organ Clav Choir Warm Pad Electric Bass

Press and hold the Split button while choosing a Voice Select button.

► **To Change the Main Voice:**

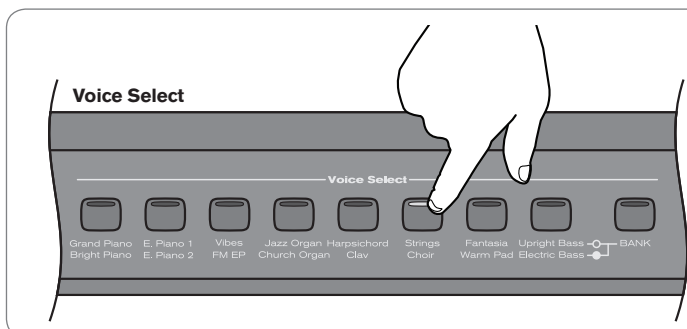

Voice Select

Grand Piano E. Piano 1 Vibes Jazz Organ Harpsichord Strings Fantasia Upright Bass BANK
Bright Piano E. Piano 2 FM EP Church Organ Clav Choir Warm Pad Electric Bass

Press a Voice Select button (without pressing the Layer or Split buttons).

► **To change the Layer Voice Volume:**

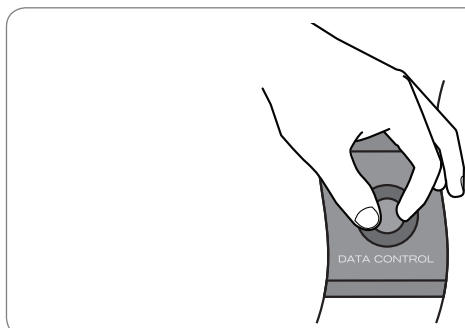

DATA CONTROL

Turn the Data Control knob to adjust the volume.

► **To change the Split Voice Volume:**

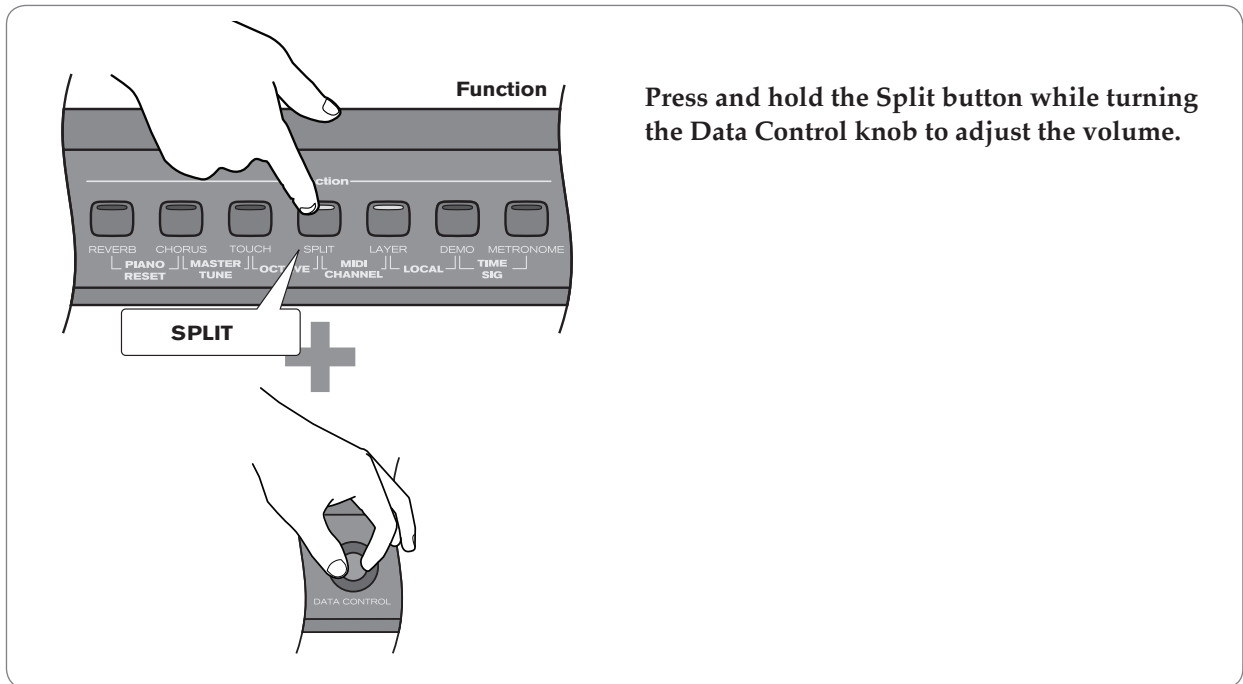

► **To change the Main Voice Volume:**

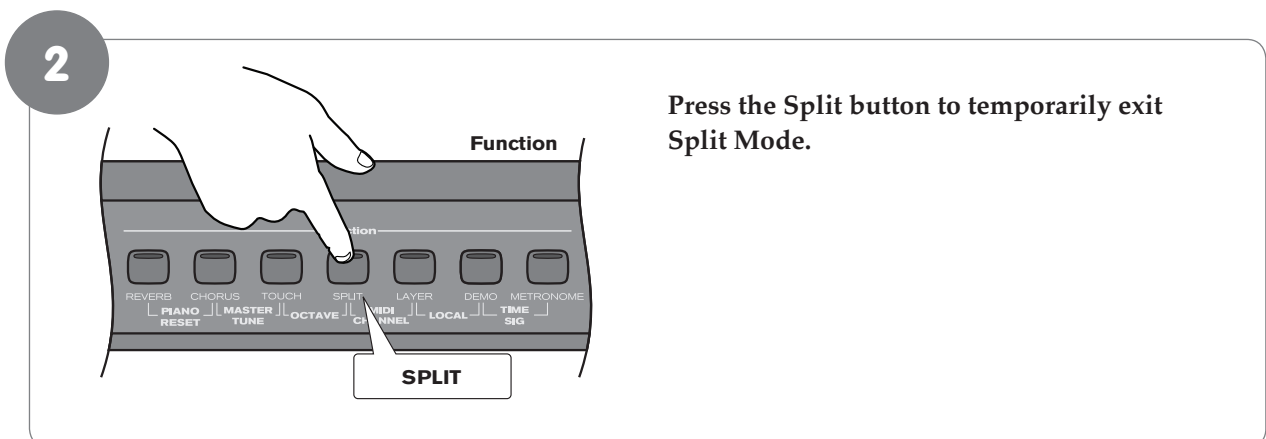
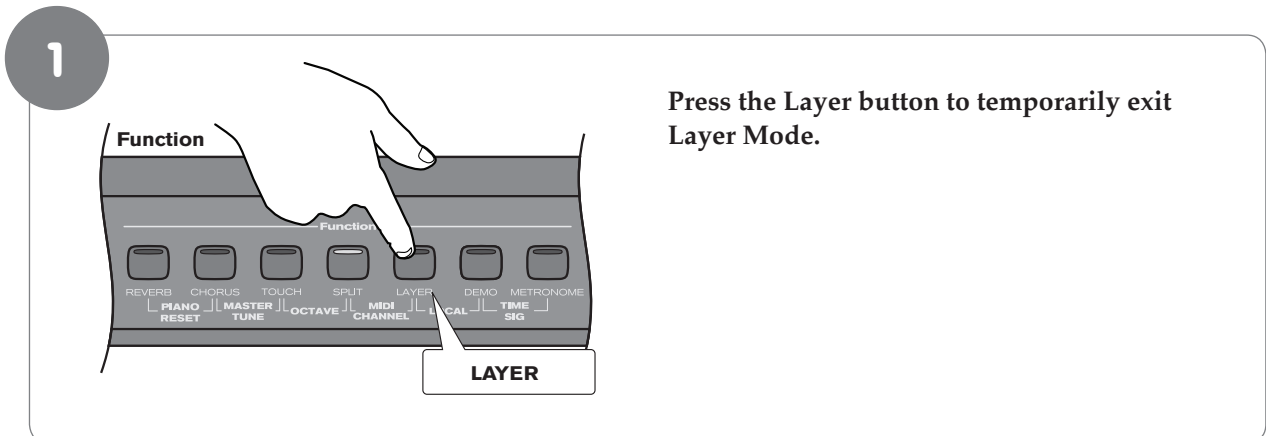

3

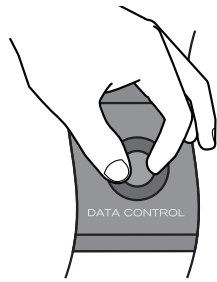

Use the Data Control knob to adjust the Main Voice volume.

4

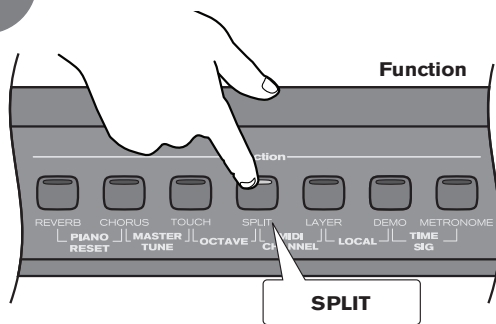

Press the Split button again to reactivate Split Mode.

5

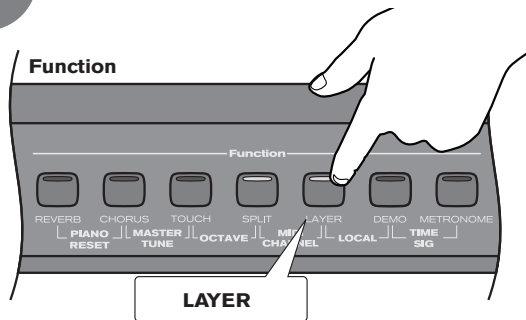

Press the Layer button again to reactivate Layer Mode.

Transpose Buttons

The Transpose Up and Down buttons are used to increase or decrease the keyboard's transpose value, up to 12 semi-tones (one octave) up or down.

► To use the Transpose Function:

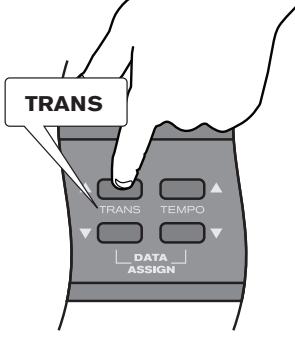

Each time you press the Transpose Up button, the pitch is raised by one semi-tone. In the same way, the Transpose Down button is used to lower the pitch in semi-tone increments.

Once you have changed the Transpose setting, the LCD will show a positive or negative value to the right of the voice name:

Grand Piano +05
Tem:120 Vol:127

Transpose Value

► To reset the Transpose setting back to its default value of zero:

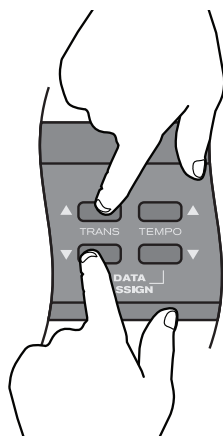

Press the Transpose Up and Transpose Down buttons at the same time.

✓ **Note:** Changes to the Transpose setting are not remembered after a power-cycle. The setting will be back at its default value of zero at power-up.

Octave Function

Enabling the Octave function allows you to raise or lower the keyboard's pitch in octave increments.

► To use the Octave function:

1

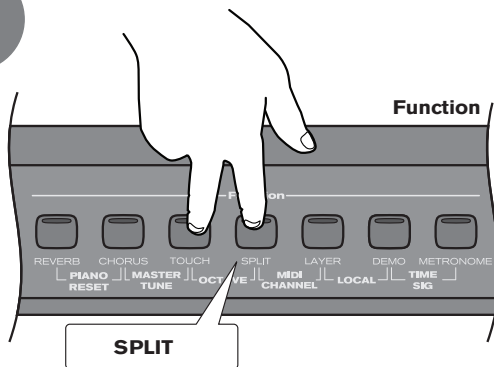

Press the Touch and Split buttons at the same time to enter Octave Shift Edit Mode.

The top line of the LCD will show:
OctaveShift: -0-

2

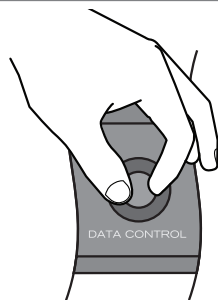

Use the Data Control knob (or the Transpose Up/Down buttons) to raise or lower the Octave Shift setting.

► To reset the Octave Shift function back to its default value of zero:

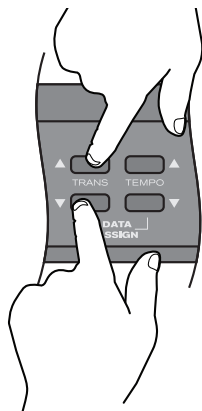

With Octave Shift Edit Mode enabled, press the Transpose Up and Down buttons at the same time.

✓ **Note:** Changes to the Octave Shift setting are not remembered after a power cycle. The setting will be back at its default value of zero at power-up.

Master Tune

Although DCP-300 never actually slips out of tune, the Master Tuning function can be helpful when playing along with another instrument that may be tuned slightly higher or lower than standard pitch.

► To adjust the Master Tune setting:

1

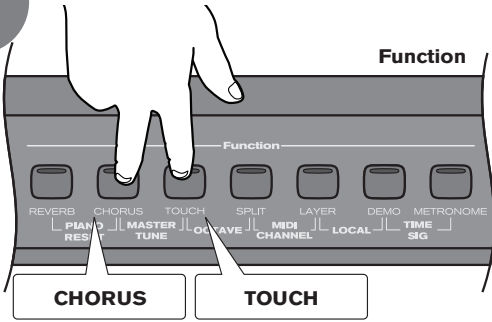

Press the Chorus and Touch buttons at the same time.

The top line of the LCD will show:
MasterTune: -0-

2

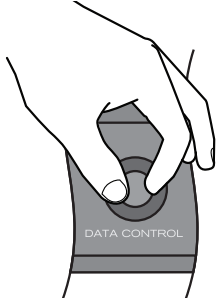

Use the Data Control knob (or the Transpose Up/Down buttons) to raise or lower the Master Tune setting.

► To reset the Master Tune value to its default value of zero:

1

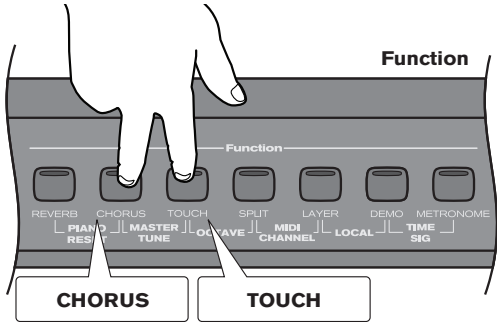

Press the Chorus and Touch buttons at the same time to enable the Master Tune function.

2

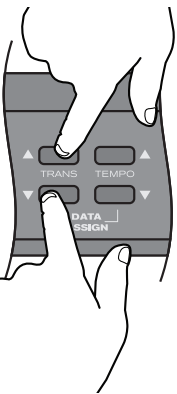

Press the Transpose up and down buttons at the same time.

✓ **Note:** Changes to the Master Tune value are remembered after a power cycle.

Also note that the Master Tune command is sent to the internal sound engine only. It will not affect MIDI sent from DCP-300 to an external MIDI device or software program.

Touch Select Mode

The Touch Sensitivity setting, sometimes referred to as the velocity curve, lets you decide how the pressure with which you hit a key determines the volume at which the note plays. DCP-300 provides you with three different sensitivity options:

- **Normal** is the default setting, and is designed to be useful for most players with an “average” touch (i.e.: people who play with an average amount of force).
- **Low** is a sensitivity setting that generates lower velocity values for the same force. This setting is useful for playing more quietly, even if you tend to strike the keys harder.
- **High** is a sensitivity setting that generates higher velocity values for the same force. This setting is useful for playing more loudly, even if you tend to strike the keys with less force.
- **Fixed** is essentially the “off” setting, effective when the Touch button is not lit. The same velocity value is sent regardless of how hard or how softly you strike the keys. The default Fixed velocity value is 100 (on a scale of 0-127), and can be adjusted (see next page).

► To select a Touch Sensitivity setting (Normal, Low, or High):

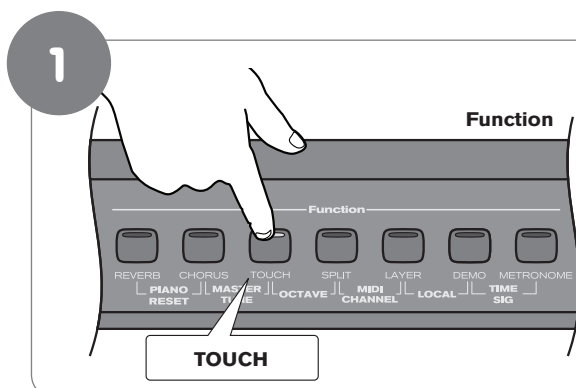

With the Touch button lit, press and hold the Touch button to enter Touch Select Mode.

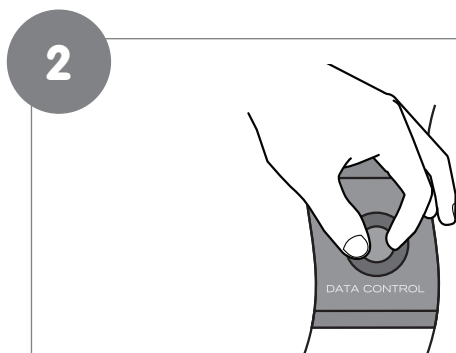

While continuing to hold down the Touch button, use the Data Control knob (or the Transpose or Tempo Up/Down buttons) to select the desired Touch setting.

As you turn the Data Control knob, the LCD will scroll through the available Touch settings. (The “NORMAL” Touch setting is shown in the example below).



Note: Pressing the Transpose up and down buttons together while in Touch Select Mode will reset the Touch function back to its default value of Normal.

Touch: **Normal**

► **To set Touch Sensitivity to Fixed (off):**

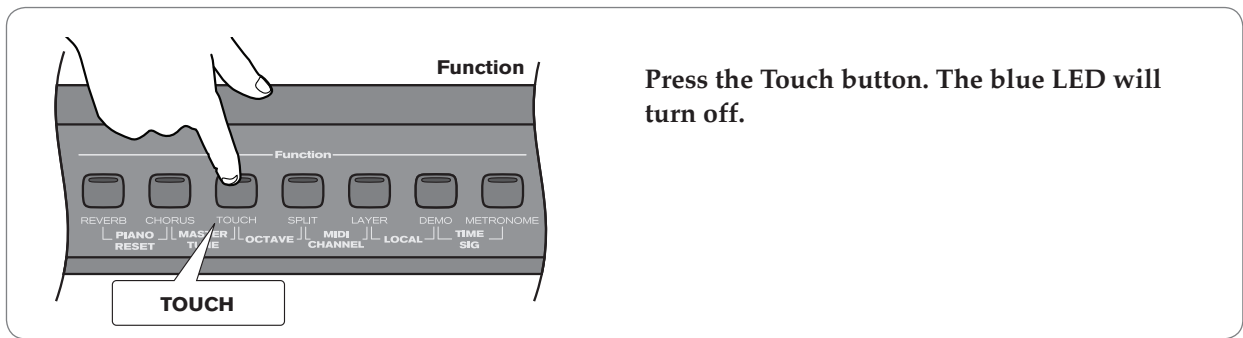

► **To change the Fixed velocity value:**

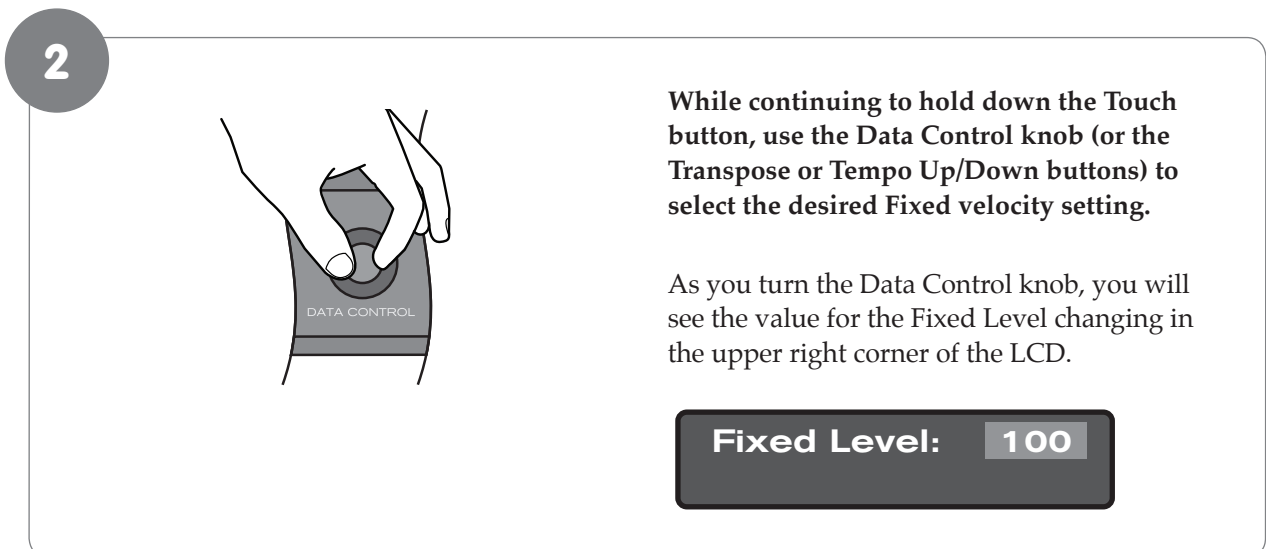
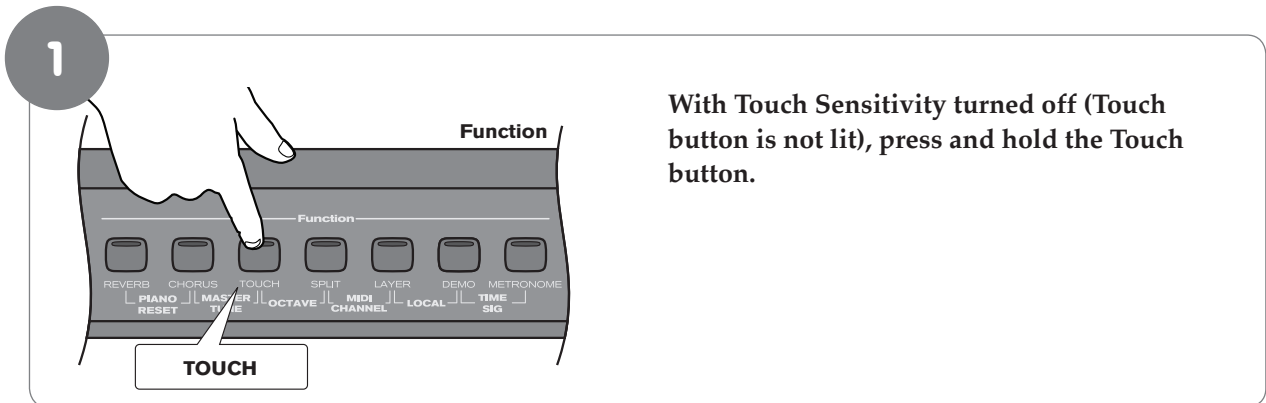

7 Resetting DCP-300: What to do if you need to Start Over

If you come to a point while using some of the advanced features built into DCP-300 where you are feeling a little lost and just want to start over, there are two ways to do this.

Method 1: Piano Reset

In most cases, this is all you will need to do. Any songs you have recorded in the Song Recorder will be preserved.

► To do a Piano Reset:

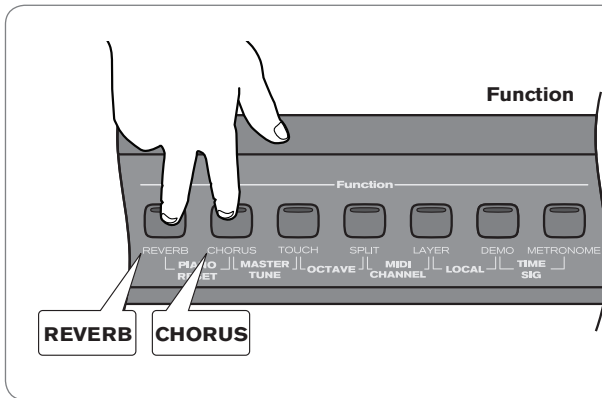

Press the Reverb and Chorus buttons at the same time.

For a list which settings are saved after a Piano Reset (or after powering DCP-300 off), as well as for a list of all MIDI messages send during a Piano Reset, please see Appendix A: Defaults.

Method 2: Factory Reset

Performing a Factory Reset will clear all battery backed memory and restore all functions to their factory defaults, just like they were when you used DCP-300 for the first time. Please note that anything you have recorded into the Song Recorder will be erased by this procedure!

► To do a Factory Reset:

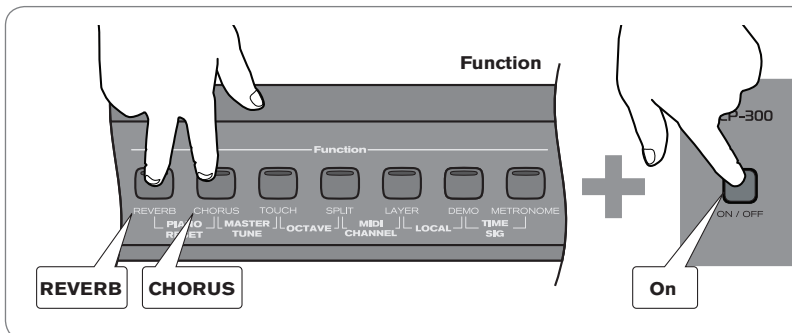

Hold down the Reverb and Chorus buttons while powering on DCP-300.

The LCD window will light all pixels, and all LEDs on the device will light while these buttons are held down. Once this has happened, you can release the Reverb and Chorus buttons.

Once the reset has finished, DCP-300 will return to Performance Mode, allowing you to play the piano normally again. All button LEDs will return to their default states. The display window will show the version number of the *firmware* (the piano's internal operating system) for 2 seconds and then return to showing the Voice Name.

DCP-300 will then function normally, as if powered on for the first time.

8 Using your Digital Console Piano with a Computer

The following section explains how to connect DCP-300 to your home computer, and how to install the included Sibelius First software.

If you are not planning to use DCP-300 with your computer at this time, please skip this section for now and move on to the “MIDI Functions” section (or just start playing your new piano).

Computer System Requirements

Most recently-manufactured home computers should meet the following requirements for use with DCP-300 and the included Sibelius First software:

Windows:

XP SP2/Vista
512 MB RAM,
600 MB hard disk space
CD-ROM drive
Available USB port

Mac:

OS X 10.4 or later, 512 MB RAM
600MB hard disk space
CD-ROM drive
Available USB port



Note: *It is not necessary to install the Sibelius First software in order to use DCP-300 with your computer. Other music software may also be used. Note that other music software may have higher system requirements than those listed above for Sibelius First.*

Connecting DCP-300 to your Computer

Your DCP-300 is class-compliant. This means you may connect your DCP-300 to your Windows XP, Windows Vista or Mac OS X computer using the provided USB cable and switch the piano on. No additional installation or drivers are required.

▶ Connecting the USB cable:

1

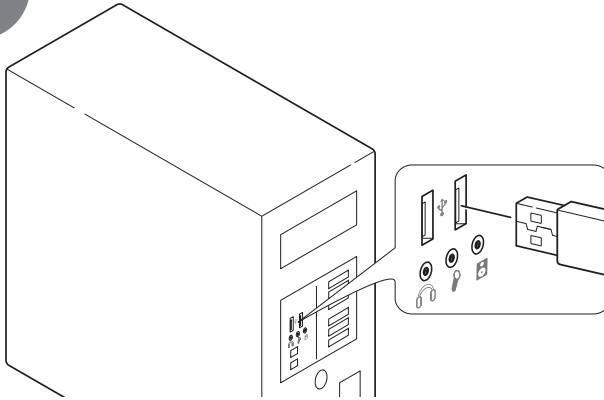

With your computer on and all programs/ applications closed, connect one end of the included USB cable to an open USB port on your computer.

2

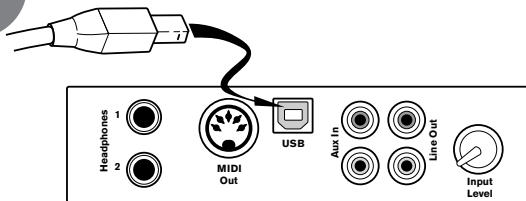

Connect the other end of the included USB cable to the USB jack on the front of the DCP-300 Connections Panel.

3

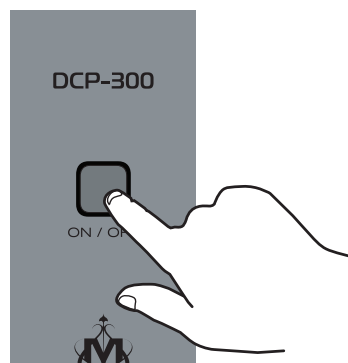

Make sure DCP-300 is powered on.

That's it! Now MIDI (Musical Instrument Digital Interface) data can be sent between DCP-300 and your computer.

Connecting the DCP-300 Auxiliary Input

The Auxiliary Input of DCP-300 allows you to connect the audio output of a computer, MP3 player, or other audio device to DCP-300, and hear that audio device play through the stereo speakers built into DCP-300. This feature can be very useful when you want to play along with pre-recorded music, or when you are working with music software.

► To connect your computer's audio output to the DCP-300 Auxiliary Input:

1

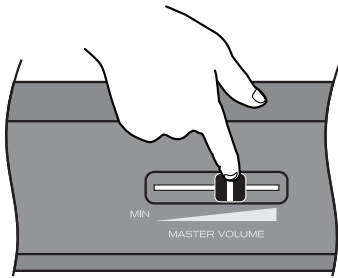

Set a comfortable volume level for DCP-300 according to the “Set a Comfortable Volume Level” instructions in the “Using DCP-300 for the First Time” section at the beginning of this User Guide.

2

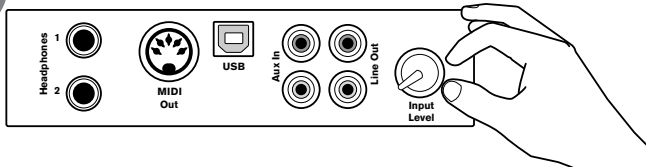

Turn the Input Level knob all the way down.

3

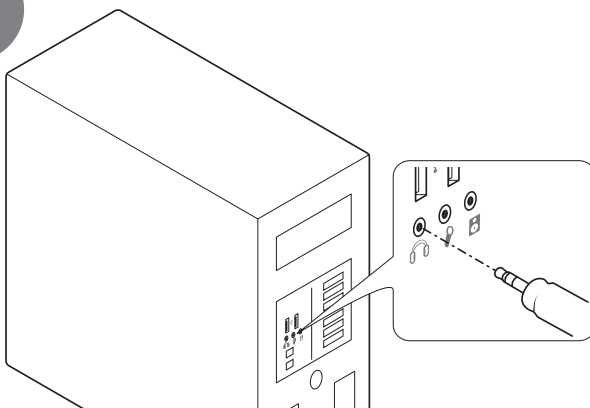

Connect the 1/8” end of the included 1/8” TRS to stereo RCA audio cable to the audio output (headphone or line output) of your computer.

(This will most likely silence your computer speakers.)

4

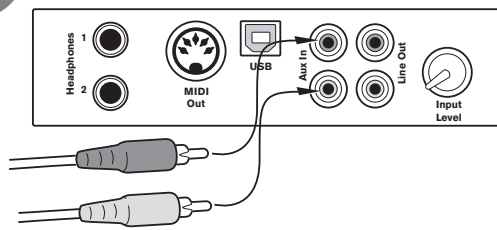

Connect the RCA plugs of the included 1/8" TRS to stereo RCA audio cable into the Aux In jacks on the DCP-300 Connections Panel.

5



Begin playing an audio file or audio CD on your computer, at the volume level you usually use.

6

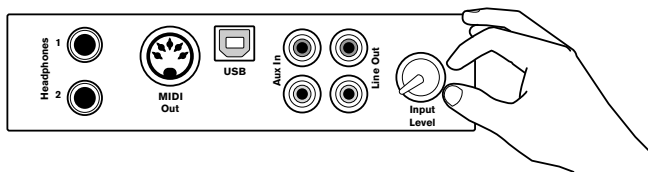

Slowly turn up the Input Level knob, until you hear the audio file playing through the DCP-300 speakers at a comfortable listening level.

You may wish to play the piano along with the music, as this can help you set a more balanced mix between the piano's built-in sounds and the external audio source.



Note: Of course, if you prefer to listen to your computer through its own speakers instead of the DCP-300 speakers, that's fine. You can still use DCP-300 with your computer either way.

Installing Sibelius First Software

1

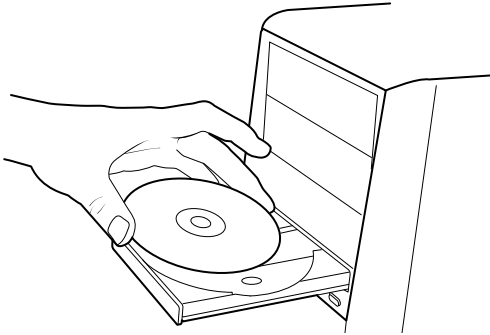

Load the Sibelius First CD-ROM into your computer's CD-ROM drive.

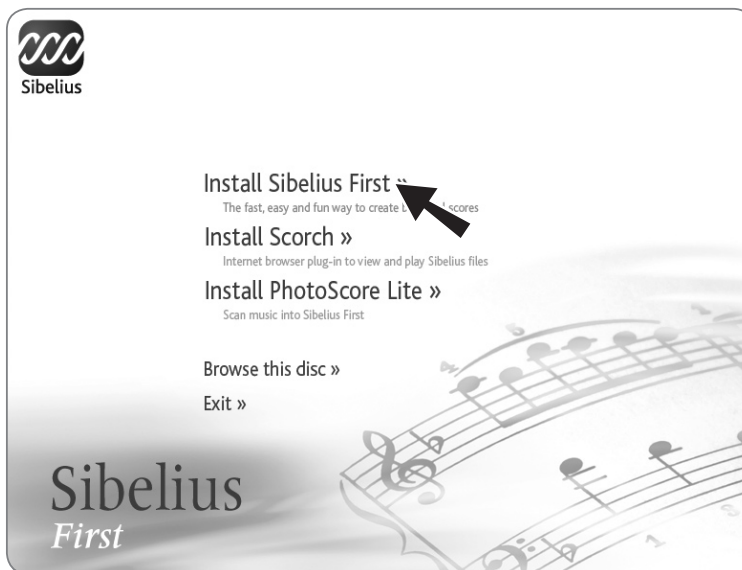

- **On Windows computers,** click "Install Sibelius First" on the window that will automatically launch.



Sibelius First

- **On Mac,** double-click on the Sibelius CD-ROM icon on the desktop-

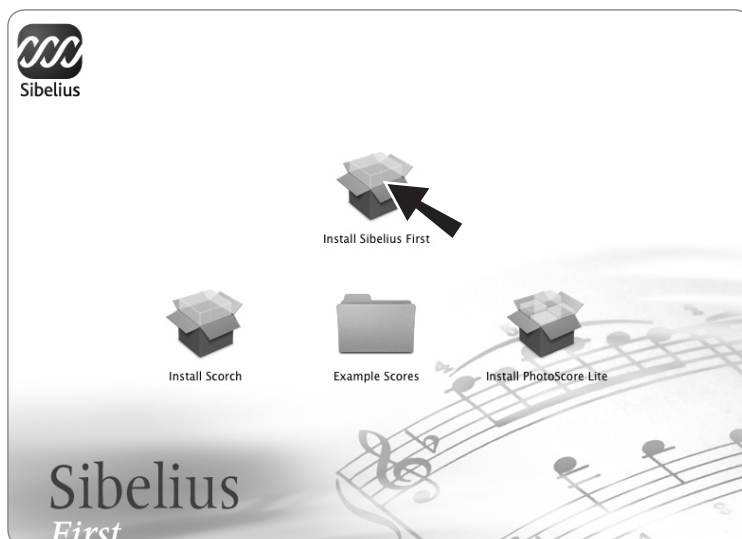

-then double-click on the Install Sibelius First icon in the window that opens.

2

Follow the on-screen prompts to install the software.

3

Once the installation has been finished, proceed to the next section:
Running the Sibelius First Software.



Note: You can also find more detailed installation instructions in the Sibelius First Installation Guide booklet included in the Sibelius First product box.

Running Sibelius First Software

1

Make sure DCP-300 is connected to your computer's USB input, and DCP-300 is powered on.

2

Launch Sibelius First:



- On Windows computers, double-click the Sibelius 5 First icon on your desktop.
- On Mac, double-click your hard disk icon, navigate to the Applications folder, then double-click the Sibelius 5 First program icon.

3

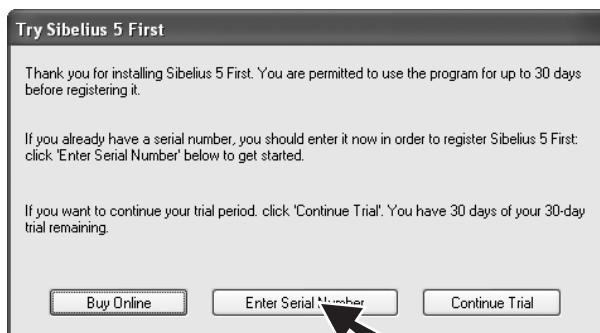

When you see the Try Sibelius First window, click the Enter Serial Number button.

4



Enter Serial Number

Please enter your Serial Number.

Your Sibelius 5 First serial number is printed on the CD case Sibelius 5 First came in.

ABCD 123 456 789 101112

Cancel OK

Enter the serial number found inside the front cover of the included Sibelius First Installation Guide booklet, and then click OK.

5



Register

How to Register

You need to register Sibelius 5 First within the first 30 days to continue enjoying full use of the program. Registering will give you access to technical help and future updates to Sibelius 5 First.

How would you like to register?

On the Internet (recommended)

By fax, phone or email

You should register on the Internet if you can because it's quick, easy and can be done at any time.

Serial Number: ABCD 123 456 789 101112

Computer Number: C 1234 5678 9012 3456

Register Later < Previous Next >

Follow the on-screen instructions to register the software.

6

When registration is complete, Sibelius 5 First will launch. When you see the Quick Start window:

- **On Windows computers:**
“Open recent file” and “Quick tour.sib” should already be selected. All you have to do is click OK.
- **On Mac:**
Choose “Open another file” and click OK on the Quick Start dialog.
 - In the Open dialog that appears, navigate to the Example Scores folder on the installation CD-ROM.
 - Double-click the Example Scores folder, then open the folder named “Other,” select the score called Quick tour, and then click Open.

A single-page excerpt from a composition by Scott Joplin called “Something Doing” will open.

7

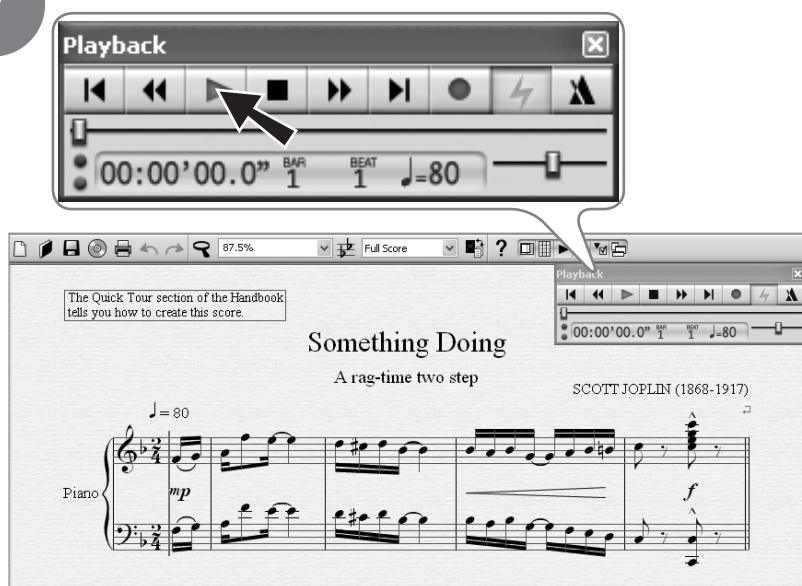

Click the Play button.

You will hear the score played back using a piano sound that is built into Sibelius-- either through your computer speakers, or through the DCP-300 speakers (if you have connected the Aux In as explained in the “Connecting the DCP-300 Auxiliary Input” section).

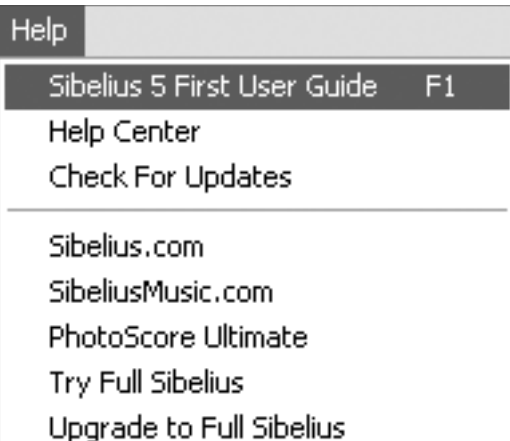

To continue learning about Sibelius First, please refer to the Sibelius First User Guide. It contains everything you need to know about using the software. The Sibelius First User Guide can be accessed from the Help menu in Sibelius First.

9 MIDI Functions

If you are an advanced MIDI user, this section will help you to access the MIDI controller capabilities of DCP-300. If you already know that you need this specialized functionality, then this section is for you. However, this information is not necessary in order to enjoy playing the piano.

MIDI, or Musical Instrument Digital Interface, is the way most electronic keyboards communicate with computers and with each other. Through a series of MIDI messages a computer or keyboard can tell an instrument what note to play, how loud to play it, when to stop playing it, and a host of other information.

DCP-300 can send MIDI information to a computer or another MIDI-capable instrument, via its MIDI or USB output. This enables DCP-300 to act as a controller keyboard for another instrument, MIDI sequencer or MIDI-enabled Digital Audio Workstation program. You can even use DCP-300 to directly input notes onto a musical score using the included Sibelius First notation software.

Local On/Off

Turning the Local On/Off function to Off will disconnect the keyboard from the internal sound engine of DCP-300. This means you can use DCP-300 as a MIDI controller to control other MIDI devices (or virtual instrument software running on your computer) without playing the internal sounds of DCP-300. You may also find other occasions (such as when you are using MIDI sequencing software on your computer) where it is useful to turn Local off.

For example: If you decided that instead of using the sounds built into the included Sibelius First music notation software, you would rather use the sounds built into DCP-300, you would choose DCP-300 as the Playback Device in Sibelius (note that DCP-300 will show up as “USB Audio Device” on Windows XP computers). You would then want to switch Local On/Off to “off” on the DCP-300 to avoid note “doubling” (where notes you play on DCP-300 actually play twice at almost the same time, diminishing the available polyphony).

► To turn Local On/Off to Off:

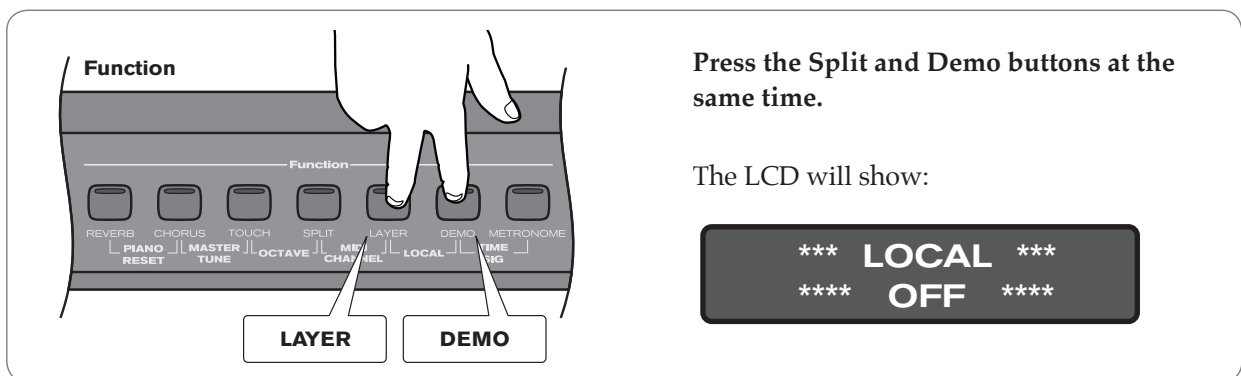

Function

Function

REVERB CHORUS TOUCH SPLIT LAYER DEMO METRONOME
 PIANO MASTER OCTAVE MELODY CHANNEL LOCAL TIME SIG
 RESET TUNE

LAYER DEMO

Press the Split and Demo buttons at the same time.

The LCD will show:

*** LOCAL ***
 **** OFF ****

► To turn Local On/Off back to On:

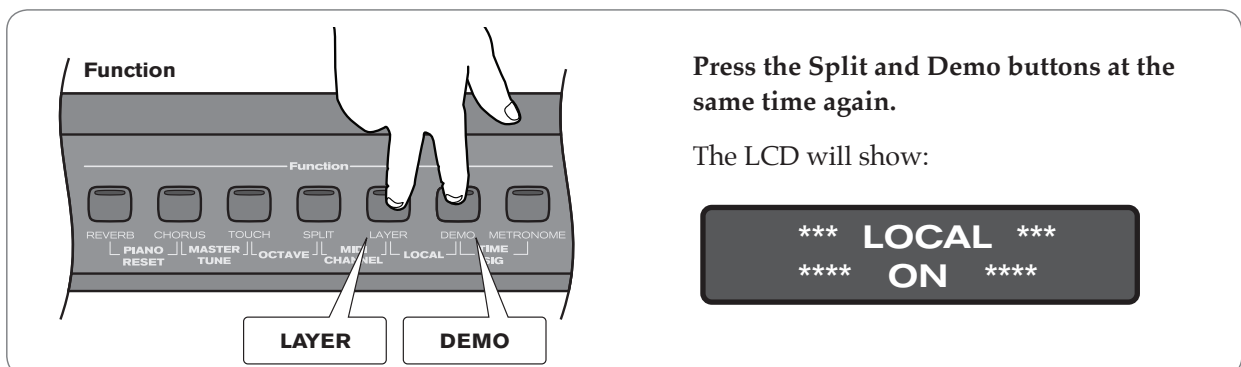

Function

Function

REVERB CHORUS TOUCH SPLIT LAYER DEMO METRONOME
 PIANO MASTER OCTAVE MELODY CHANNEL LOCAL TIME SIG
 RESET TUNE

LAYER DEMO

Press the Split and Demo buttons at the same time again.

The LCD will show:

*** LOCAL ***
 **** ON ****

MIDI Channel

This function allows you to use the Data Control knob (or Transpose Up/Down buttons) to increase or decrease the Main MIDI Transmit Channel. The Main MIDI Transmit Channel is the MIDI channel used for the Main Voice.

► To change the Main MIDI Transmit Channel:

1

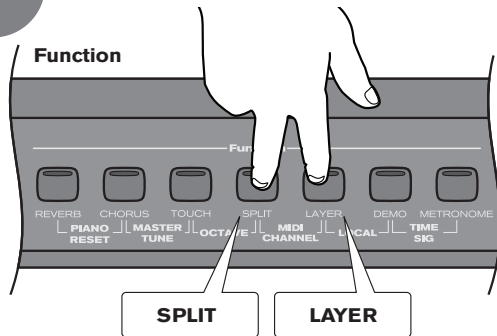

Press the Split and Layer buttons simultaneously to enter MIDI Channel Edit Mode.

The display will begin flashing the current Main MIDI Transmit Channel:

Midi Chan: 001

2

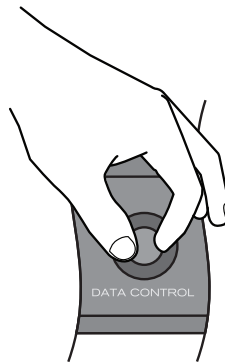

Use the Data Control knob or the Transpose Up or Down buttons to change the Main MIDI Transmit Channel.

The new Main MIDI Transmit Channel will be selected and shown in the display. For example, if Channel 12 is selected, the display will show:

Midi Chan: 012

If the keyboard is being played at the time of the MIDI Channel change, all new notes played will be sent on the new MIDI Channel. All held notes will play their note off messages on the MIDI Channel on which they were played.

While in MIDI Channel Edit Mode, pressing the Transpose up and down buttons together will reset the Main MIDI Transmit Channel function back to its default value of Channel 1.

Data Control Assign

Though it controls Voice Volume by default, the Data Control knob can be assigned to send control messages for a variety of functions, including Octave, Master Tuning, MIDI Program Change, Tempo, and any of the standard MIDI CC (Control Change) messages. A table containing all the possible Data Control knob assignments can be found in Appendix C – Data Control Assignments and MIDI CC List.

Note that the Data Control Assignment is remembered after a power cycle.

► To change the assignment of the Data Control knob:

1

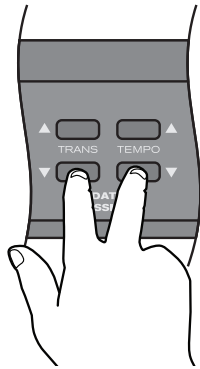

Press the Transpose Down and Tempo Down buttons at the same time.

2

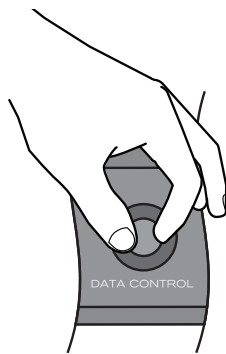

Turn the Data Control knob to scroll through the possible assignments until you see the desired assignment on the LCD.

After approximately three seconds, the keyboard will go back into Performance Mode, with your new Data Control knob assignment.

Please note that the default assignment for the Data Control knob is 007-VolumC.



Note: In Step 2 you may use either the Transpose Up/Down or Tempo Up/Down buttons instead of the Data Control knob to scroll through the possible assignments.

■ Adjusting Split and Layer Voice Volume when Data Control knob has a custom assignment:

Regardless of the Data Control knob assignment, you can always adjust the Split Voice volume or Layer Voice volume by holding down the Split or Layer button while turning the Data Control knob.

10 Care and Maintenance

As with all furniture, avoid placing items directly on the piano (such as drink glasses, potted plants, etc.) that may cause moisture damage to the piano's finish.

Cleaning should be done with a soft, dry cloth (or if necessary, a slightly damp cloth). Chemical cleaning products should not be used, as they may harm the piano's finish.

11 Troubleshooting

Your DCP-300 digital piano has been tested under a wide variety of conditions to ensure trouble-free performance. In the event that you do experience any difficulty, this section provides tips to help resolve some basic issues you may encounter.

Problem: My piano keyboard is working correctly, but the pedals do not seem to be working.

Solution: Make sure the Pedal Board cable is firmly connected to the Pedal Connector on the piano's rear panel.

Problem: My piano is on with the volume turned up, but I do not hear any sound when I play the keyboard.

Solution 1: Local On/Off may be set to Off, or the currently selected voice's volume may be turned down. In either case, a Piano Reset will fix the problem. To do a Piano reset, press the Reverb button and Chorus button at the same time for one second.

Solution 2: If the Master Volume knob is turned up, but you do not hear sound from the piano's built-in speakers, make sure nothing is plugged into Headphone Output 1.

Problem: When I turn on the piano, the LCD does not light up, and I do not hear any sound.

Solution: Make sure one end of the AC cable is connected to the jack on the piano's rear panel, and that the other end is plugged into an electrical outlet. If the AC cable is plugged into a power strip, make sure the power strip is switched on.

Problem: My piano is not being recognized by my music software.

Solution: The USB cable between the computer and the DCP-300 piano must be connected (and the piano powered on) before the music software is launched.

With the USB cable connected and DCP-300 powered on, try quitting the software and then launching it again.

Refer to the documentation which came with your software to learn how to make sure DCP-300 is properly selected within the software.

Note that on Windows XP computers, DCP-300 will show up as "USB Audio Device."

12 Appendices

Appendix A – Defaults

Default Settings

The table below shows the DCP-300 factory default settings and whether or not user changes to these settings are retained after a power-cycle (turning the device off and on):

Parameter	Factory Default	Retained on Power-Down
Program Number & Voice Selected	0	No
Voice Button Bank Selection	Off	No
Bank MSB Number	0	No
Bank LSB Number	0	No
Transmit Channel	00 (channel 1)	No
Octave shift	0	No
Transpose	0	No
Local	On	No
Data Control Assignment	Data = cc: 007 Volume	Yes
Data Control Value (per assignment and only CC - not including PGM or Bank LSB/MSB)	Value of cc:007	Yes
Velocity Curve Selected	'NORMAL'	Yes
Voice Volume	127	Yes
Metronome Volume	127	Yes
Master Tune	0	Yes
Tempo	120	Yes
Reverb On/Off	Reverb On	Yes - store for each sound
Reverb Depth	Defaults for each sound	Yes - store for each sound
Reverb Type	Defaults for each sound	Yes - store for each sound
Chorus On/Off	Chorus Off	Yes - store for each sound
Chorus Depth	Defaults for each sound	Yes - store for each sound
Chorus Type	Defaults for each sound	Yes - store for each sound
Split Mode On/Off	Off	No
Split Point	Eb3	Yes
Split Mode Voice	8 - Upright Bass	Yes
Split Volume	127	Yes
Layer Mode On/Off	Off	No
Layer Mode Voice	7 - Strings	Yes
Layer Volume	100	Yes

At power-on, the following MIDI data will be sent to the sound engine, the USB MIDI and the MIDI Out:

1. Bank Change MSB=0, LSB=0, PGM=0 - Set sound engine to piano voice
2. Reverb default value
3. Chorus default value

Reverb and Chorus Defaults

No.	Sound Name	Reverb On/Off	Reverb Depth	Reverb Type	Chorus On/Off	Chorus Depth	Chorus Type
0	Grand Piano	On	40	4	Off	64	2
1	Bright Piano	On	40	0	Off	50	3
2	E. Piano 1	On	35	1	On	35	2
3	E. Piano 2	On	38	1	Off	35	3
4	Vibes	On	35	4	Off	40	2
5	FM EP	On	50	4	On	40	2
6	Rock Organ	On	48	1	Off	64	1
7	Church Organ	On	96	5	Off	50	3
8	Harpsichord	On	50	0	Off	35	2
9	Clav	On	35	1	On	45	4
10	Strings	On	54	4	Off	35	2
11	Choir	On	127	4	Off	50	1
12	Fantasia	On	64	4	Off	45	1
13	Warm Pad	Off	40	4	Off	35	2
14	Upright Bass	Off	35	6	Off	35	3
15	Electric Bass	Off	35	0	On	45	1
MIDI Channel 10	n/a (Metronome)	Off			Off		

Piano Reset

As soon as the Piano Reset function is activated (by pressing the Reverb and Chorus buttons simultaneously), the device will perform the following functions:

1. Turn Local On
2. Send 'All Notes Off' Command on MIDI Channel 1 - external and to the internal sound engine
3. Send 'Reset All Controllers' Command on MIDI channel 1 - external and to the internal sound engine
4. Assign Data Control to MIDI Controller 7 (Volume)
5. Set Volume levels for Main Voice, Split Voice and Layer Voice to defaults
6. Set Pan to 64 for Main Voice, Split Voice and Layer Voice
7. Turn off Layer Mode and Split Mode
8. Set Global Transmit Channel to 1
9. Set Transpose and Octave Shift both back to zero
10. Send a Bank Change MSB = 0 and Bank Change LSB = 0 on channel 1
11. Send a Program Change = 0 on channel 1
12. Send the Reverb Depth back to the default value for the Piano Voice
13. Send the Chorus Depth back to the default value for the Piano Voice
14. Send the current status of the Sustain Pedal on channel 1

The device will remain in Performance Mode during the Piano Reset function. The LCD display will show 'Piano Reset' for 1 second and then return to the default display.

Appendix B - MIDI Implementation

Function...		Transmitted	Recognized	Remarks
Basic Channel	<i>Default Changed</i>	1-16	1-16	
		1-16	1-16	
Mode	<i>Default Messages Altered</i>	Mode 3	Mode 3	
		0 *****	X X	
Note Number	<i>True Voice</i>	0-127 *****	0-127	
Velocity	<i>Note ON Note OFF</i>	0	0	
		0	0	
After Touch Keys Channel		X	X	
		X	X	
Pitch Bend		X	X	
Control Change		0-127	0, 1, 5, 6, 7, 10, 11, 32, 64, 65, 66, 67, 80, 81, 91, 93, 100, 101, 121	
Program Change True #		0-127 *****	0-15	*16 sounds only PGM=0-15
System Exclusive		0*	0*	*The controller will recognize and respond to GM Device Inquiry. Master Tune supported Master Volume supported
System Exclusive	<i>Song Position Pointer</i>	X	X	
	<i>Song Sel</i>	X	X	
	<i>Tune Request</i>	X	X	
Tune Request		X	X	
System Clock		X	X	
Real Time Commands		X	X	
Aux All Sounds Off*		0	0	
Messages Reset All Controllers		0	0	
Local ON/OFF*		0	0	
All Notes OFF		0	0	
Active Sensing		X	0	
System Reset		X	0	
Notes				

Mode 1: OMNI ON, POLY Mode 2: OMNI ON, MONO 0: Yes

Mode 3: OMNI OFF, POLY Mode 4: OMNI OFF, MONO X: No

Appendix C - Data Control Assignments and MIDI CC List

Below is a list of MIDI controllers that can be assigned to the Data Control knob:

CC no.	Controller Name	Display Name	Name (3 char)	Default Value
	Octave	Octave	Oct	0
	Transpose	Transpose	Tra	0
	Voice Volume	Voice Vol	Vol	127
	Layer Volume	Layer Vol	Vol	100
	Split Volume	Split Vol	Vol	127
	Metronome Volume	Metro Vol	Vol	100
	Time Signature	Time Sig	TSg	4/4
	Program Change ⁵	PGM Change	PGM	0
	Bank Change LSB ⁵	Bank LSB	LSB	0
	Bank Change MSB ⁵	Bank MSB	MSB	0
	MIDI Transmit Channel	MIDI Chan	Cha	1
	Voice Select	Voice Sel	Sel	0
	Master Tune	Master Tune	Tun	64
	Tempo	Tempo	Tem	120
0	0 Bank Select (coarse)	000-Bank C	CC	0
1	1 Modulation Wheel (coarse)	001-Mod C	CC	0
2	2 Breath controller (coarse)	002-BrethC	CC	0
3		3	CC	0
4	4 Foot Pedal (coarse)	004-FootPC	CC	0
5	5 Portamento Time (coarse)	005-PortaC	CC	0
6	6 Data Entry (coarse)	006-DataEC	CC	0
7	7 Volume (coarse)	007-VolumC	Vol	127
8	8 Balance (coarse)	008-BalanC	CC	0
9		9	CC	0
10	10 Pan position (coarse)	010-Pan C	Pan	64
11	11 Expression (coarse)	011-Expr C	Exp	127
12	12 Effect Control 1 (coarse)	012-Eff1 C	CC	0
13	13 Effect Control 2 (coarse)	013-Eff2 C	CC	0
14		14	CC	0
15		15	CC	0
16	16 General Purpose Slider 1	016-GenPr1	CC	0
17	17 General Purpose Slider 2	017-GenPr2	CC	0
18	18 General Purpose Slider 3	018-GenPr3	CC	0
19	19 General Purpose Slider 4	019-GenPr4	CC	0
20-31		020, 021, 022 ... 031	CC	0
32	32 Bank Select (fine)	032-Bank F	CC	0
33	33 Modulation Wheel (fine)	033-Mod F	CC	0
34	34 Breath controller (fine)	034-BrethF	CC	0
35		35	CC	0
36	36 Foot Pedal (fine)	036-FootPF	CC	0
37	37 Portamento Time (fine)	037-PortaF	CC	0
38	38 Data Entry (fine)	038-DataEF	CC	0
39	39 Volume (fine)	039-VolumF	CC	127
40	40 Balance (fine)	040-BalanF	CC	0
41		41	CC	0
42	42 Pan position (fine)	042-Pan F	CC	0
43	43 Expression (fine)	043-Expr F	CC	127

CC no.	Controller Name	Display Name	Name (3 char)	Default Value
44	44 Effect Control 1 (fine)	044-Eff1 F	CC	0
45	45 Effect Control 2 (fine)	045-Eff2 F	CC	0
46-63		046, 047, 048 ... 063	CC	0
64	64 Hold Pedal (on/off)	064-Sustai	CC	0
65	65 Portamento (on/off)	065-Portam	CC	0
66	66 Sostenuto Pedal (on/off)	066-Sosten	CC	0
67	67 Soft Pedal (on/off)	067-SoftPd	CC	0
68	68 Legato Pedal (on/off)	068-Legato	CC	0
69	69 Hold 2 Pedal (on/off)	069-HoldP2	CC	0
70	70 Sound Variation	070-Var	CC	64
71	71 Sound Timbre	071-Timbre	CC	64
72	72 Sound Release Time	072-Releas	CC	64
73	73 Sound Attack Time	073-Attack	CC	64
74	74 Sound Brightness	074-Bright	CC	64
75	75 Sound Control 6	075-CTRL 6	CC	0
76	76 Sound Control 7	076-CTRL 7	CC	0
77	77 Sound Control 8	077-CTRL 8	CC	0
78	78 Sound Control 9	078-CTRL 9	CC	0
79	79 Sound Control 10	079-CTRL10	CC	0
80	80 General Purpose Button 1 (on/off)	080-GenBt1	CC	4
81	81 General Purpose Button 2 (on/off)	081-GenBt2	CC	2
82	82 General Purpose Button 3 (on/off)	082-GenBt3	CC	0
83	83 General Purpose Button 4 (on/off)	083-GenBt4	CC	0
84-90		084, 085, 086 ... 090	CC	0
91	91 Effects Level	091-FXLevl	CC	35
92	92 Tremolo Level	092-Tremel	CC	0
93	93 Chorus Level	093-Chorus	CC	0
94	94 Celeste Level	094-Celest	CC	0
95	95 Phaser Level	095-Phaser	CC	0
96	96 Data Button increment	096-DatInc	CC	0
97	97 Data Button decrement	097-DatDec	CC	0
98	98 Non-registered Parameter (fine)	098-NRPN F	CC	127
99	99 Non-registered Parameter (coarse)	099-NRPN C	CC	127
100	100 Registered Parameter (fine)	100-RPN F	CC	127
101	101 Registered Parameter (coarse)	101-RPN C	CC	127
102-119		102, 103, 104 ... 119	CC	0
120	120 All Sound Off	120-SndOff	CC	0
121	121 All Controllers Off	121-CTLOff	CC	0
122	122 Local Keyboard (on/off)	122-Local	CC	0
123	123 All Notes Off	123-NoteOf	CC	0
124	124 Omni Mode Off	124-OmniOf	CC	0
125	125 Omni Mode On	125-OmniOn	CC	0
126	126 Mono Operation	126-Mono	CC	0
127	127 Poly Operation	127-Poly	CC	0

⁵ Program Change, Bank LSB and Bank MSB when assigned to the Data Control are sent out over USB-MIDI and MIDI Out but do not affect the internal sound engine. (Note, these messages do affect the internal sounds when they are received over USB-MIDI.)

13 Warranty

Warranty Terms

M-Audio warrants products to be free from defects in materials and workmanship, under normal use and provided that the product is owned by the original, registered user.

Visit www.m-audio.com/warranty for terms and limitations applying to your specific product.

Warranty Registration

Immediately registering your new M-Audio product entitles you to full warranty coverage and helps M-Audio develop and manufacture the finest quality products available. Register online at www.m-audio.com/register to receive FREE product updates and for the chance to win M-Audio giveaways.

Documentation Feedback

At M-Audio, we're always looking for ways to improve our documentation. If you have comments, corrections, or suggestions regarding our documentation, email us at publications@m-audio.com

© 2009 Avid Technology, Inc. All rights reserved. Product features, specifications, system requirements and availability are subject to change without notice. Avid, M-Audio and DCP-300 are either trademarks or registered trademarks of Avid Technology, Inc. All other trademarks contained herein are the property of their respective owners.

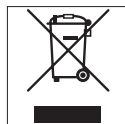

WARNING: This product contains chemicals, including lead, known to the State of California to cause cancer, and birth defects or other reproductive harm. *Wash hands after handling.*

M-Audio USA | Avid Technology • M-Audio | www.m-audio.com
5795 Martin Rd., Irwindale, CA 91706

Technical Support	web www.m-audio.com/tech tel (pro products) (626) 633-9055	fax (shipping) (626) 633-9032 tel (consumer products) (626) 633-9066
Sales	e-mail sales@m-audio.com	tel (866) 657-6434 fax (626) 633-9070

M-Audio UK | Avid Technology • M-Audio | www.maudio.co.uk
Pinewood Studios, Pinewood Road, Iver Heath, Bucks, SL0 0NH, United Kingdom

Technical Support	e-mail support@maudio.co.uk	tel (Mac/PC support) +44 (0)1753 658630
Sales	tel +44 (0) 1753 659590	

M-Audio Benelux | Avid Technology • M-Audio | www.m-audio.com
Vreelandseweg 42 A, 1216 CH Hilversum, The Netherlands

Technical Support	Belgium / Luxemburg tel +32 22 54 88 93	Netherlands tel +31 35 625 0097
Sales	e-mail benelux@m-audio.com	tel +31 (0)35 625 0093 fax +31 (0)35 625 0090

M-Audio France | Avid Technology • M-Audio | www.m-audio.fr
44 Avenue Georges Pompidou, 92300 Levallois-Perret, France

Renseignements Commerciaux	email info@m-audio.fr	tel 0 810 001 105
Assistance Technique	e-mail (PC) support@m-audio.fr email (Mac) mac@m-audio.fr	PC 0 820 000 731 Mac 0 820 391 191 fax +33 (0)1 72 72 90 52

M-Audio Germany | Avid Technology • M-Audio | www.m-audio.de
Zeppelinstr. 1, D-85399 Hallbergmoos, Germany

Technical Support	email support@m-audio.de	tel +49 (0)7941 - 9870030
Sales	e-mail info@m-audio.de	tel +49 (0)811 5520 555 fax +49 (0)811 5520 599

M-Audio Canada | Avid Technology • M-Audio | www.m-audio.ca
1400 St-Jean Baptiste Ave. #150, Quebec City, Quebec G2E 5B7, Canada

Technical Support	e-mail techcanada@m-audio.com	tel (418) 872-0444 fax (418) 872-0034
Sales	e-mail infocanada@m-audio.com	tel (866) 872-0444 fax (418) 872-0034

M-Audio Japan | エムオーディオ/アビッドテクノロジー株式会社 | www.m-audio.jp
〒107-0052 東京都港区赤坂2-11-7 ATT新館ビル4F(4F ATT Bldg. 2-11-7 Akasaka, Minato-ku Tokyo 107-0052 Japan)

テクニカルサポート (Technical Support)	e-mail majsupport@m-audio.com	tel 03-3505-4034 fax 03-3505-3417
セールス (Sales)	e-mail sales@m-audio.jp	tel 03-3505-7963 fax 03-3505-3417